

Solution for charge/discharge testing of batteries



A data logger that's ideal for capturing data from high-voltage battery pack cells

Product concept

Battery packs consist of a large number of cells connected in series. Since variability in cell characteristics can lead to a decline in the battery pack's overall performance, it's critically important to ascertain voltage and temperature behavior at the cell level. Manufacturers are designing batteries of increasingly high voltage for use in electric vehicles (EVs). As battery voltages rise from 400 V to 800 V, it becomes harder to measure battery cells' voltage and temperature safely. Instruments used to conduct charge/discharge testing of these high-voltage battery packs must now have high-terminal-to-ground and module-to-module voltage then before.



Product features

- **Maximum rated terminal-to-ground voltage 1500 V DC (CAT II) insulation**
- **10 ms sampling with 1500 channels**
(20 ms sampling with 3000 channels)
- **HIL support with a data output interval as short as 5 ms**

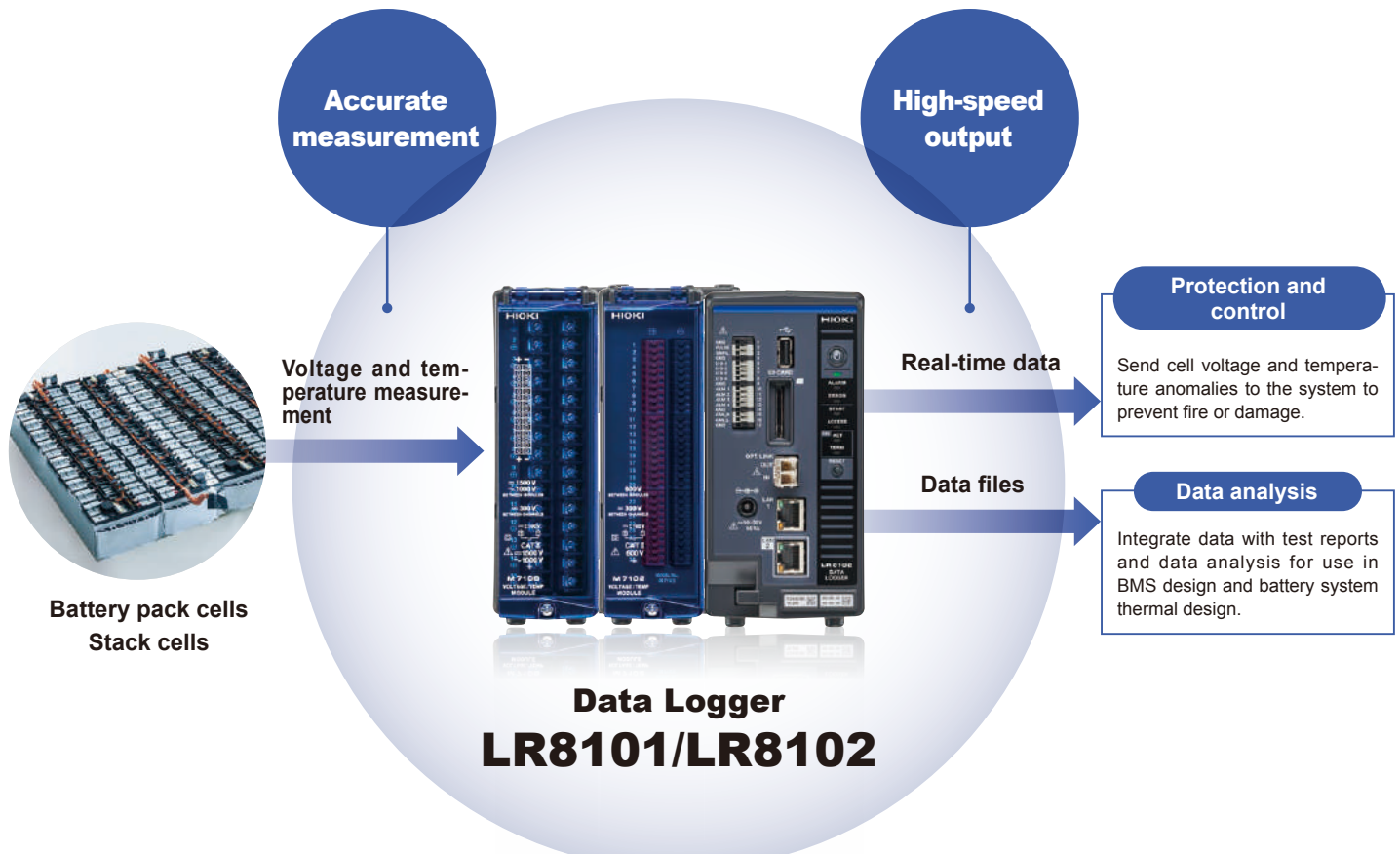

Advantages

- 1**



Safely measure voltage at all cells of high-voltage batteries

1500 V DC CAT II insulation performance that complies with the EN IEC 61010 safety standard
- 2**



Expand to as many as 3000 channels as the system grows

Support for 15 to 3000 channels by adding modules
- 3**



Realize real-time data output at an interval as short as 5 ms with UDP output

Use live data for battery cells as a trigger for HIL systems or protective functions.

Product Components

The product makes measurements by combining a data logger with one or more measurement modules.

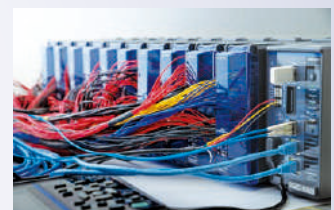
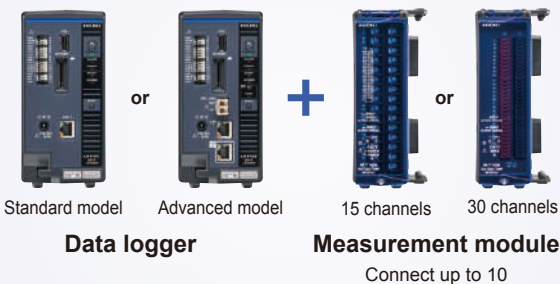

Product line

Data Loggers

Select from two logger models. If you wish to synchronize sampling and use more than measurement modules, you'll need at least two LR8102 loggers.



Standard model

Data Loggers LR8101

Basic functionality needed to collect general-purpose data

Connect up to 10 measurement modules per logger

Send data to a computer via LAN



Advanced model

Data Loggers LR8102

Support for large-scale systems and real-time simulations

Synchronize sampling across up to 10 main units

Extensive communications interfaces for high-speed data transfers

Connect up to 10 measurement modules per logger

Send data to a computer via LAN

Maximum number of connectable modules (measurement modules)	10 (M7100, M7102)	10 (M7100, M7102)
Maximum number of synchronizable loggers	-	10 (requires optical connection cables)
Maximum number of measurable channels (data refresh interval)	<ul style="list-style-type: none"> · 80 channels (5 ms) · 150 channels (10 ms) · 300 channels (20 ms) 	<ul style="list-style-type: none"> · 800 channels (5 ms) · 1500 channels (10 ms) · 3000 channels (20 ms)
Communications interface(s)	LAN1	LAN1, LAN2, CAN
LAN 1 (communications commands, data download)	Data collection and recording condition configuration via Logger Utility; setting configuration, recording control, FTP server function, FTP client function, HTTP server function, and XCP on Ethernet (TCP) via communications commands	
LAN 2 (real-time data output)	-	<ul style="list-style-type: none"> · Data output with refresh interval as short as 5 ms via UDP · XCP on Ethernet (UDP)
CAN (real-time data output)	-	Data output with refresh interval as short as 5 ms via CAN or CAN FD
External control terminals	Pulse/logic input, external sampling input, external I/O (4), alert output (4), CAN interface (LR8102 only)	

Measurement modules

Choose measurement modules based on the number of channels and the required maximum rated module-to-module and terminal-to-ground voltages.

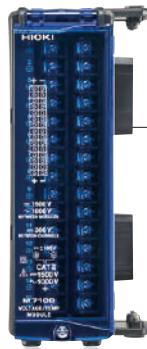

Max. 1500 V

Voltage/Temp Module M7100

- For systems ranging from 600 V to 1500 V
- Measure up to 15 channels with one module at a maximum sampling rate of 5 ms.

Voltage

Temperature



Max. 600 V

Voltage/Temp Module M7102

- For systems of 600 V or less
- Measure up to 30 channels with one module at a maximum sampling rate of 10 ms.

Voltage

Temperature

Number of measurable channels	15 channels	30 channels
Minimum data refresh interval (number of usable channels)	5 ms (1 to 8 channels) (voltage only) 10 ms to 10 sec (9 to 15 channels)	10 ms (1 to 15 channels) 20 ms to 10 sec (16 to 30 channels)
Measurement parameters	Voltage, temperature (thermocouple)	Voltage, temperature (thermocouple)
Measurement range (voltage)	Voltage: 10 mV f.s. to 100 V f.s.	Voltage: 10 mV f.s. to 100 V f.s.
Resolution and precision when using the 6 V range	60 μ V resolution, ± 3 mV accuracy	60 μ V resolution, ± 3 mV accuracy
Input resistance	100 M Ω or greater (10 mV to 6 V range) 1 M Ω $\pm 5\%$ (10 V to 100 V range)	100 M Ω or greater (10 mV to 6 V range) 1 M Ω $\pm 5\%$ (10 V to 100 V range)
Maximum input voltage	± 100 V DC	± 100 V DC
Maximum channel-to-channel voltage	300 V DC	300 V DC
Maximum rated module-to-module voltage	1500 V DC, 1000 V AC	600 V DC, 600 V AC
Maximum rated terminal-to-ground voltage	1500 V DC, 1000 V AC (CAT II)	600 V DC, 600 V AC (CAT II)

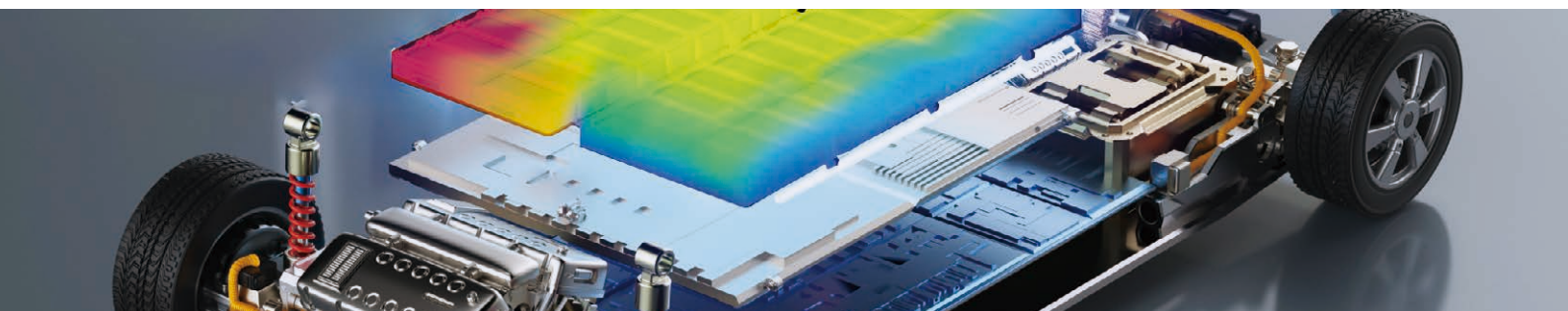
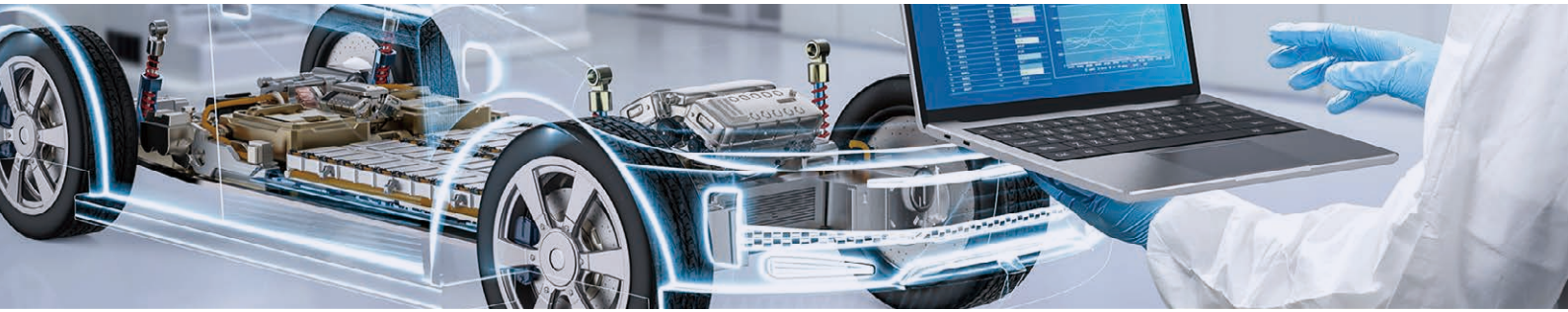

Applications

- Assessing cell charge/discharge characteristics
- Verifying cell balance
- Evaluating thermal management
- Evaluating performance with an HIL system
- Detecting test system errors



Example setup

This section introduces a setup capable of measuring standard 400 V battery packs as well as 800 V battery packs, which are already being commercialized.

Example of interoperation with a charge/discharge tester Capturing data for all cells in a 400 V battery pack

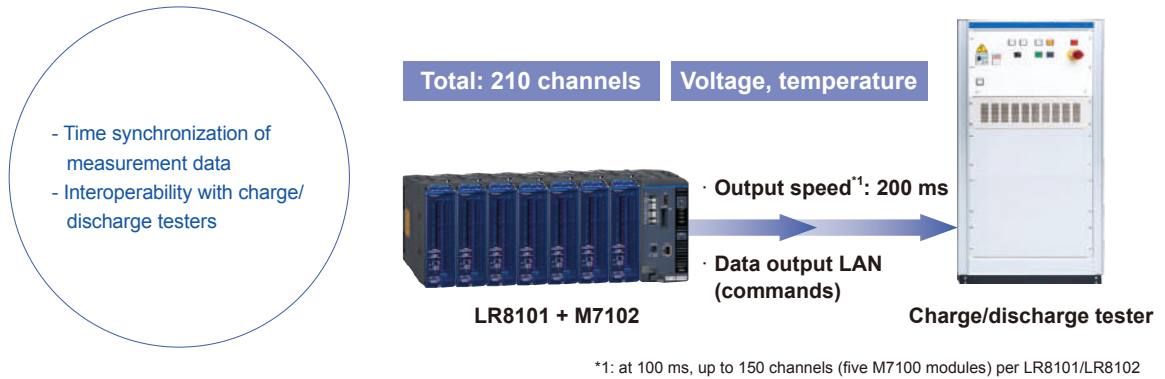

Measurement conditions	Setup
<ul style="list-style-type: none"> · 210 channels (30 channels × 7 modules) · Sampling interval: 200 ms · Communication interface: LAN1 · Communication protocol: TCP (communication commands) 	<ul style="list-style-type: none"> · Data Logger LR8101 × 1 · Voltage/Temp Module M7102 × 7 · LAN Cable 9642 × 1

Example of interoperation with a next-generation high-voltage battery testing systems Building a system for testing battery packs that exceed 800 V

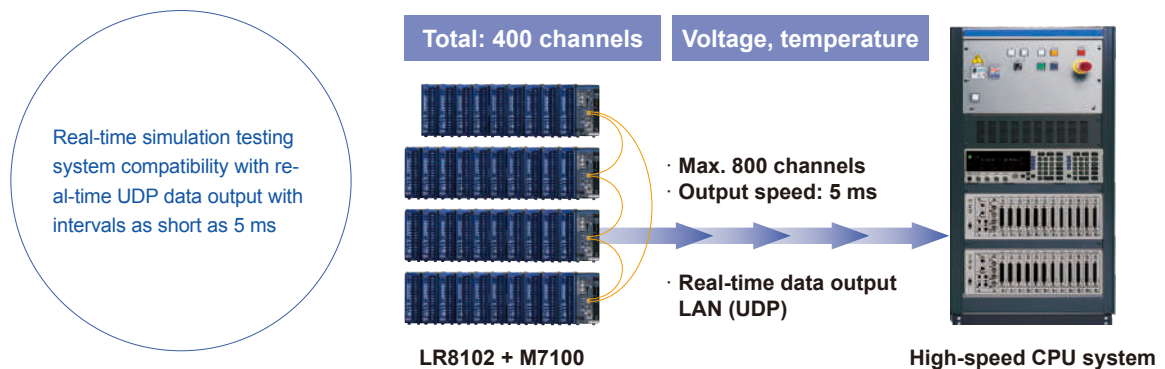

Measurement conditions	Setup
<ul style="list-style-type: none"> · 400 channels · Sampling interval: 5 ms (voltage), 10 ms (temperature) · Communication interface: LAN2 · Communication protocol: UDP 	<ul style="list-style-type: none"> · Data Logger LR8102 × 4 · Voltage/Temp Module M7100 × 39 200 voltage channels: M7100 × 25 (8 channels per module) 200 temperature channels: M7100 × 14 (15 channels per module) · Optical Connection Cable L6101 (1 m) × 3 · Optical Connection Cable L6102 (10 m) × 1 <p><small>* A hub and one LAN cable for each logger are needed in order to simultaneously configure multiple devices. Use of Cat 7 cabling is recommended since large amounts of data will be transferred at high speed.</small></p>

| Advantage 1 |

Safely measure voltage at all cells of high-voltage batteries

The LR8101 and LR8102 data loggers are ideal for embedding in battery testing systems.

In battery pack charge/discharge testing, technicians acquire voltage and temperature data for each cell, allowing them to assess battery characteristics in a comprehensive manner.

Maximum rated module-to-module and terminal-to-ground voltages

1500 V DC (CAT II) insulation

Although the voltage of individual cells in a battery may be low at about 4 V, safely measuring the voltage at each cell in an 800 V battery pack, a type that is already being commercialized, requires an instrument with a maximum rated terminal-to-ground voltage of at least 800 V DC.

Since the Voltage/Temp Module M7100 has a maximum rated terminal-to-ground voltage of 1500 V, it can accommodate testing of 800 V batteries with an ample margin of safety. It can also be used to measure cell voltage and temperature in next-generation battery packs that exceed 800 V and power storage systems such as energy storage systems (ESSs) that exceed 1000 V.

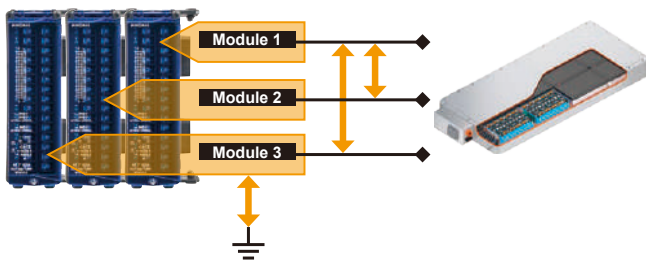

Mixing of modules

Caution: when using a mix of different measurement modules to measure targets such as battery packs that are connected in series, the lower of the two maximum rated module-to-module voltage specifications applies.

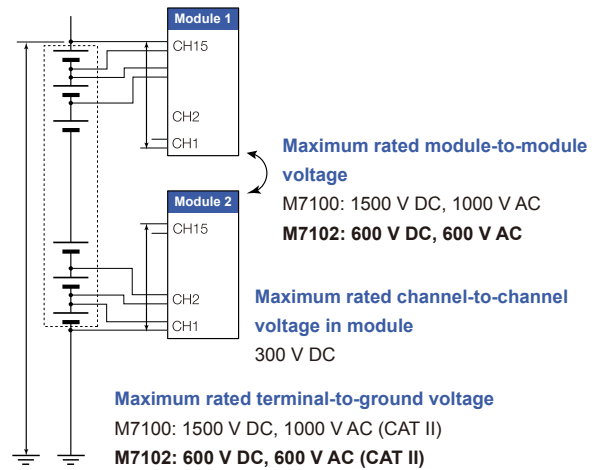

Safe, EN IEC 61010-compliant design



When measuring voltage or electrode temperature at cells that make up a battery pack, high voltages will be applied between terminals and ground (between input channels and ground) and between measurement modules.

The Voltage/Temp Module M7100 uses a newly designed isolation transformer to realize 1500 V DC insulation between input channels and ground. Safety and reliability are assured thanks to the device's ability to withstand not only steady high voltages, but also transitory voltage surges. The module complies with the EN IEC 61010 international standard, ensuring that it meets safety requirements for battery measurement.

| Advantage 2 |

Expand to as many as 3000 channels as the system grows

The LR8101/LR8102 can be expanded in a flexible manner based on the necessary number of measurement channels. The expandable nature of the logger (starting at one logger and module) also means that it will take only as much space as is necessary. Space no longer needs to be wasted on large loggers that take up more space than the application requires.

Support for multi-channel measurement

Synchronized measurement of up to 3000 channels

The Data Logger LR8101/LR8102 is used in combination with one or more measurement modules. If 10 M7102 modules, which can each measure 30 channels, are connected, a single instrument can measure up to 300 channels. Furthermore, if up to 10 of the LR8102 advanced models are connected with optical cabling, their sampling can be synchronized, allowing the number of measurement channels to be increased to a maximum of 3000.

Add channels with a space-saving design

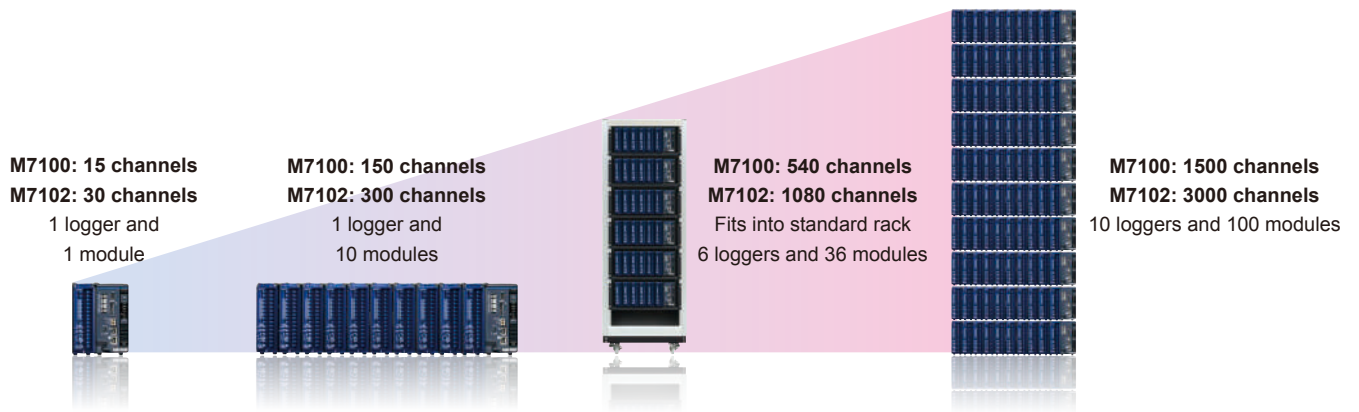

Synchronized sampling with multiple loggers

LR8102 only

By daisy-chaining loggers together with the L6101 or L6102 optical connection cables, sampling-synchronized measurement can be performed for up to 10 loggers. An optical connection cable is required for each logger.



Example of synchronized measurement with 3 loggers

LAN conceptual connection diagram

Data can be acquired and settings configured from multiple devices by using a hub and LAN cables.

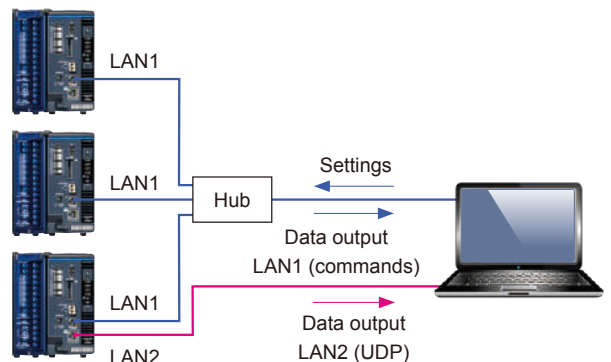

The LR8102's LAN connection for UDP output

- Data is output from the LAN2 port. Use of Cat 7 cabling is recommended since large amounts of data will be transferred at high-speed.
- The loggers' settings are configured from the LAN1 port of each logger via hub when using UDP output.

| Advantage 3 |

Realize real-time data output at an interval as short as 5 ms with UDP output

LR8102 only

The LR8102 can be embedded in testing systems such as HIL systems, which perform simulations while transferring measurement data at high speeds.

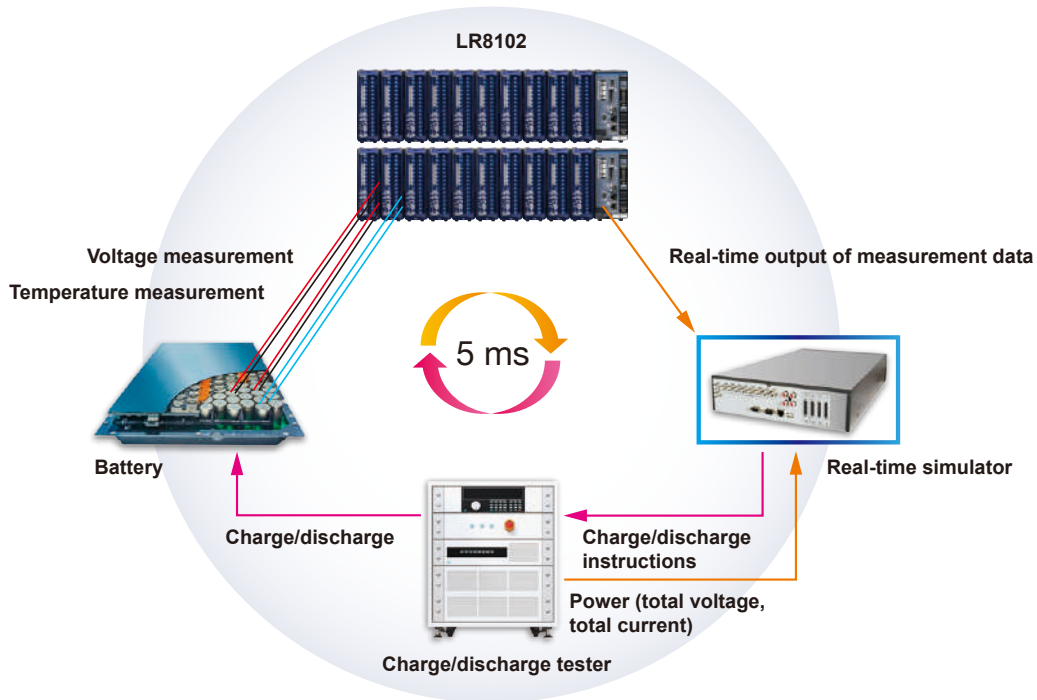

Support for HIL system-linked simulation testing

When using measured data to develop a battery-related control simulation, it's necessary to transfer measurement data to the system at high-speed.

Since the LR8102 uses UDP to output one datapoint at a time at an interval as short as 5 ms, it's ideal for interoperability with HIL systems.

Synchronization with charge/discharge tester data

Since the LR8102 is so fast that it can keep up with the fast charge/discharge and measurement performed by the charge/discharge tester. This time-precision can drastically improve the overall detail and accuracy of the simulation.

Data output

Data can be output at an interval as short as 5 ms by using UDP output, CAN output, or XCP via Ethernet (all of which are supported exclusively by the LR8102). Operating conditions may be subject to limitations depending on the usage environment. For detailed conditions, please see the instruction manual found on Hioki's website.

Output method		Logger Utility	Communications commands	UDP output	CAN output	XCP on Ethernet
Shortest sampling interval		10 ms	100 ms	5 ms	5 ms	5 ms
Number of loggers (for which sampling can be synchronized)		5	10	10	10	10
Maximum number of input channels (for which sampling can be synchronized)		600 channels	1500 channels (100 ms) Up to 150 channels per logger (5 modules) 3000 channels (200 ms) Up to 300 channels per logger (10 modules)	800 channels (5 ms) 1500 channels (10 ms) 3000 channels (20 ms)	150 channels (5 ms) 300 channels (10 ms) 600 channels (20 ms) (Reference value when receiving data on CAN FD 1 port)	800 channels (5 ms) 1500 channels (10 ms) 3000 channels (20 ms) (LAN2)
Output port	LAN1	✓	✓	-	-	✓
	LAN2	-	-	✓	-	✓
	CAN	-	-	-	✓	-
How to obtain sample program		· Found on included DVD · Most recent version can be downloaded from Hioki's website ^{*1}	· Found in User Documentation (on included DVD) · Sequence Maker ^{*2}	· Found on included DVD	-	-

*1: <https://www.hioki.co.jp/jp/support/software/download/> *2: <https://sequencemaker.hioki.com/ja/>

Included software

Collect data on a computer at an interval as short as 10 ms

Logger Utility

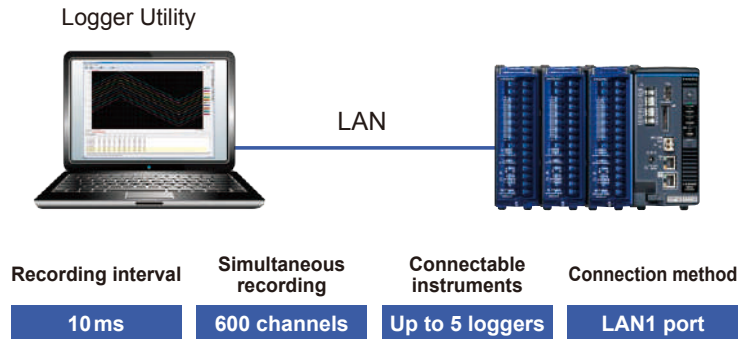

Analyze measured values as waveforms

You can check charge/discharge characteristics with the Logger Utility.

Example charge/discharge characteristics waveform

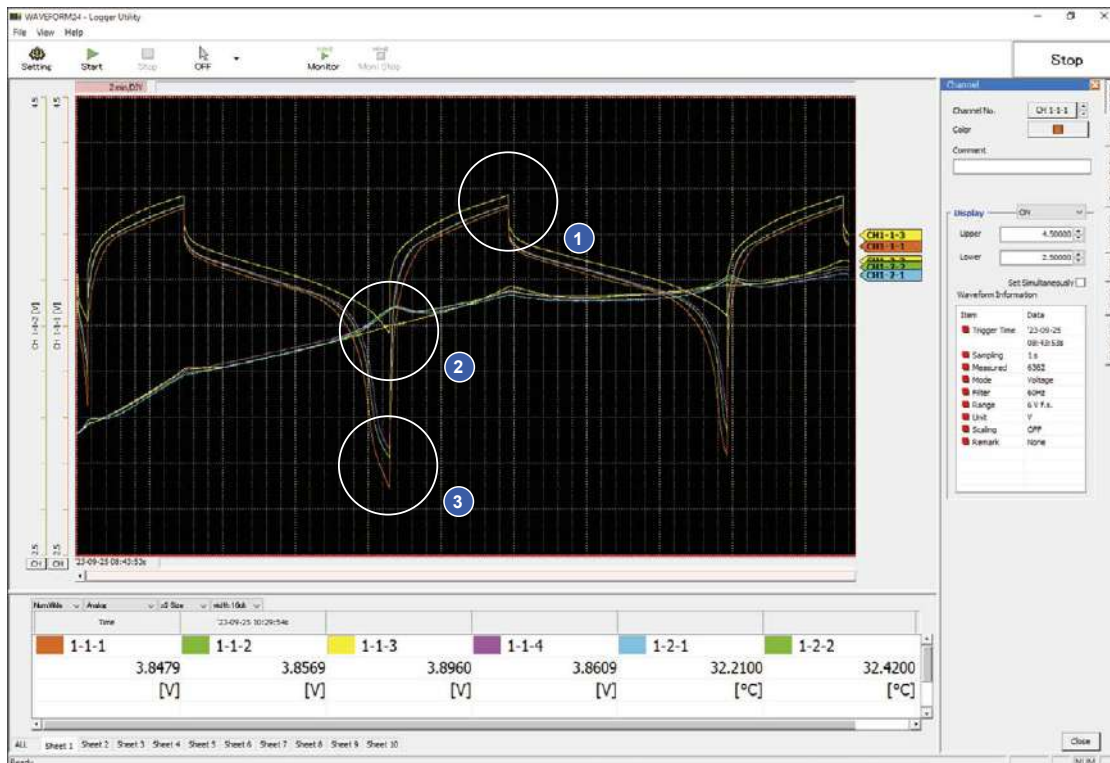

- 1 You can see that the time required to reach the charging upper-limit voltage varies from cell to cell.
- 2 You can see that the package temperature varies from cell to cell.
- 3 You can see that the time required to reach the discharge final voltage varies from cell to cell.

Interfaces

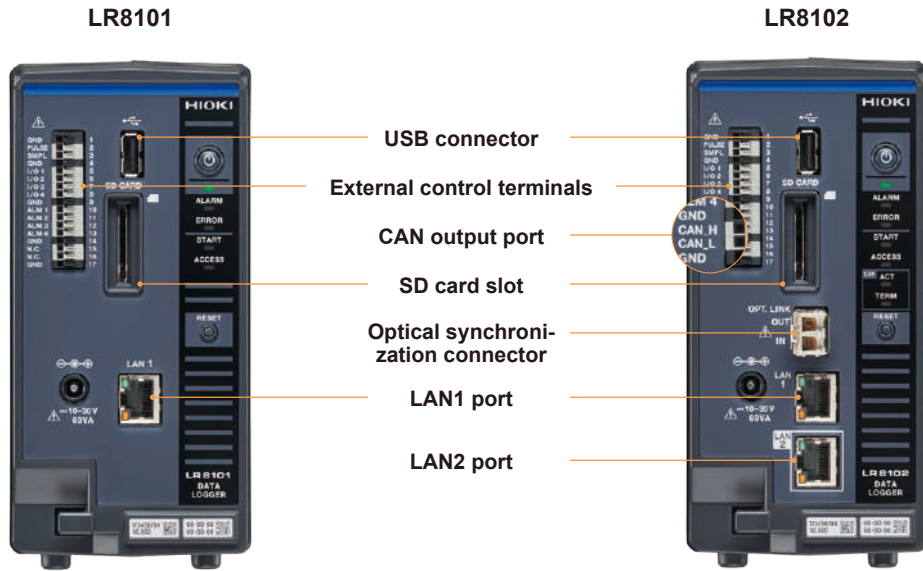

LAN ports

LAN1 can be used to configure settings using communications commands and to collect data. LAN2 (LR8102 only) can be used to output measurement data in real time using the UDP protocol.

CAN output port (LR8102 only)

This port can be used to output measured values to a CAN bus in real time while measurement is in progress.

Optical synchronization (LR8102 only)

The number of measurement channels provided by the LR8102, which supports large-scale systems, can be increased to a maximum of 3000 by connecting multiple loggers with optical connection cables (sold separately).

External control terminals

Alarm functionality

You can have the logger sound a tone or output an alarm signal to an external device when the measurement data satisfies the set condition.

External sampling

Data can be sampled and recorded in synchronization with an external clock.

External dimensions

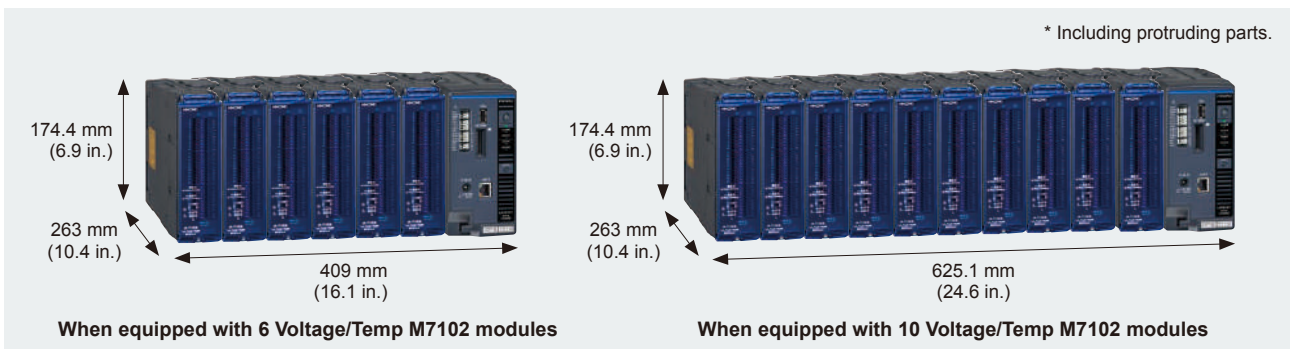
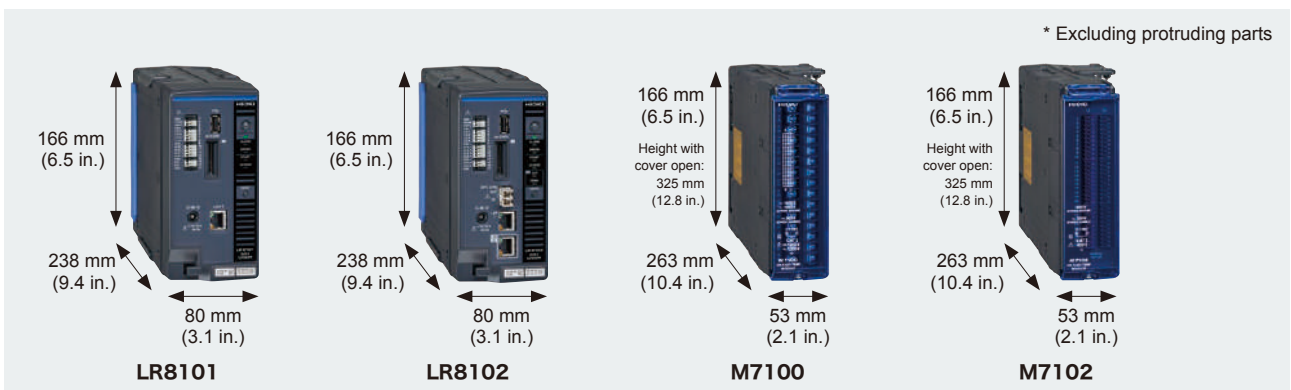

Specifications

Data Logger LR8101/LR8102 specifications

Maximum number of connectable modules	10
Measurement modules	M7100 Wireless Voltage/Temp Module (15 channels) M7102 Wireless Voltage/Temp Module (30 channels)
Operating temperature and humidity range	-10°C to 50°C (14°F to 122°F), 80% RH or less (non-condensing)
Storage temperature and humidity range	-20°C to 60°C (-4°F to 140°F), 80% RH or less (non-condensing)
External dimensions	Approx. 80W × 166H × 238D mm (3.1W × 6.5H × 9.4D in.) (excluding protruding parts)
Weight	Approx. 1.5 kg (3.3 lbs)
Included accessories	Operating Precautions ×1, Startup Guide ×1, DVD ×1

Power supply

AC adapter	Z1016 AC Adapter (drives instrument at 12 V DC ±10%)
External power supply	10 V to 30 V DC

Interfaces

Number of LAN ports	1 (LR8101) 2 (LR8102)
LAN1 functionality	Collecting data and setting recording conditions using Logger Utility Setting IP address initial settings using Logger Utility Configuring settings and controlling recording using communication commands Manually acquiring data using the FTP server Automatically sending data via FTP (FTP client) HTTP server function XCP on Ethernet (TCP) NTP client function
LAN2 functionality (LR8102 only)	Measurement data can be output by UDP XCP via Ethernet (UDP)
USB interface (host)	USB drive Guaranteed operation: Z4006 (16 GB)
SD card slot	SD memory card/SDHC memory card support Guaranteed operation: Z4001 (2 GB), Z4003 (8 GB)
External control terminals	Pulse/logic input, external sampling input, external I/O (4), alarm output (4), CAN interface (LR8102 only), GND terminals (5)

Synchronized operation (multiple loggers can operate in a synchronized manner; LR8102 only)

Maximum number of synchronizable instruments	10
--	----

Illustration of rack-mounted installation

One logger and six modules can be installed in each row of a 19-inch rack.



Voltage/Temp Module M7100 specifications

Operating temperature and humidity range	-10°C to 50°C (14°F to 122°F), 80% RH or less (no condensation)
Withstand voltage	7.4 kW AC, for 1 minute between input channels (+/-), 1 mA of sensed current) and LR8101/LR8102 or between modules 350 V AC, 1 min. (sensed current, 1 mA) between input channels (+, -)
External dimensions	Approx. 53W × 166H × 263D mm (2.1W × 6.5H × 10.4D in.) (excluding protruding parts)
Weight	Approx. 1.3 kg (2.9 lbs)
Number of input channels	15 channels

Input terminal	M3 screw-type terminal block (2 terminals per channel), terminal block cover
Measurement targets	Voltage Temperature (thermocouples, K, J, E, T, N, R, S, B, C)
Input type	Scanning by semiconductor relay, floating unbalanced input, all channels isolated
A/D resolution	18 bits
Maximum input voltage	±100 V DC
Max. channel-to-channel voltage	300 V DC
Maximum rated terminal-to-ground voltage	1500 V DC, measurement category III, anticipated transient overvoltage of 8000 V 1000 V AC, measurement category III, anticipated transient overvoltage of 6000 V
Maximum rated module-to-module voltage	1500 V DC, 1000 V AC
Input resistance	100 MΩ or greater for voltage ranges of 10 mV f.s. to 6 V f.s. (including "1–5 V f.s. range"); for all thermocouple ranges 1 MΩ ±5% (for voltage ranges 10 V f.s. to 100 V f.s.)
Data refresh interval	5 ms ^{*1} , 10 ms ^{*2} , 20 ms, 50 ms, 100 ms, 200 ms, 500 ms, 1 s, 2 s, 5 s, 10 s ^{*1} : when all the module's measurement channels are set to a voltage range and one to eight channels are being used ^{*2} : when thermocouple wire break detection is disabled
Measurement ranges	Voltage: 10 mV f.s., 20 mV f.s., 100 mV f.s., 200 mV f.s., 1 V f.s., 2 V f.s., 6 V f.s., 10 V f.s., 20 V f.s., 60 V f.s., 100 V f.s., 1 to 5 V f.s. Thermocouple: 100°C f.s., 500°C f.s., 2000°C f.s.

Voltage/Temp Module M7102 specifications

Operating temperature and humidity range	-10°C to 50°C (14°F to 122°F), 80% RH or less (no condensation)
Withstand voltage	Between input channels (+, -) and the LR8101/ LR8102: 3.6 kV AC, for 1 minute (sensed current, 1 mA) Between each module: 3.6 kV AC, for 1 minute (sensed current, 1 mA) Between each input channel (+, -): 350 V AC, for 1 minute (sensed current, 1 mA)
External dimensions	Approx. 53W × 166H × 263D mm (2.1W × 6.5H × 10.4D in.) (excluding protruding parts)
Weight	Approx. 1.2 kg (2.6 lbs)
Number of input channels	30 (configure voltage or thermocouple for each channel)
Input terminal	Push-button type terminal block (2 terminals per channel), terminal block cover
Measurement parameters	Voltage Thermocouple (K, J, E, T, N, R, S, B, C)
Input type	Scanning by semiconductor relay, floating unbalanced input All channels isolated
A/D resolution	18 bits
Max. input voltage	±100 V DC
Max. channel-to-channel voltage	300 V DC
Max. rated terminal-to-ground voltage	600 V AC/DC, measurement category III, anticipated transient overvoltage of 4000 V
Max. rated module-to-module voltage	600 V AC/DC
Input resistance	100 MΩ or greater for voltage ranges 10 mV f.s. to 6 V f.s. (including "1–5 V f.s. range") and for all thermocouple ranges 1 MΩ ±5% for voltage ranges 10 V f.s. to 100 V f.s.
Data refresh interval	10 ms ^{*1} , 20 ms ^{*2} , 50 ms, 100 ms, 200 ms, 500 ms, 1 s, 2 s, 5 s, 10 s ^{*1} : when thermocouple wire break detection is disabled and the number of channels in use ranges from 1 to 15. ^{*2} : when thermocouple wire break detection is disabled, or when thermocouple wire break detection is enabled and the number of channels in use ranges from 1 to 15.
Measurement ranges	Voltage: 10 mV f.s., 20 mV f.s., 100 mV f.s., 200 mV f.s., 1 V f.s., 2 V f.s., 6 V f.s., 10 V f.s., 20 V f.s., 60 V f.s., 100 V f.s., "1–5 V f.s. range" Thermocouple: 100°C f.s., 500°C f.s., 2000°C f.s.

Selection Guide

Step 1 **Choose a data logger**

Choose a logger based on the number of channels and data output method.

Standard model



Data Logger LR8101

or

Advanced model



Data Logger LR8102

Step 2 **Choose a power supply**

An AC adapter or power cable must be purchased separately.



AC Adapter Z1016
Powers the logger using commercial power (AC power)

or



Power Cable L1012
Powers the logger using an external power supply (DC power)

Step 3 **Choose measurement modules**

Choose measurement modules based on the required terminal-to-ground voltage, number of channels, and sampling rate.



15 channels
Max. 1500 V

Voltage/Temp Module M7100

or



30 channels
Max. 600 V

Voltage/Temp Module M7102

Step 4 **Prepare a LAN cable**

Connect the computer to the logger (LAN1 port).
A hub and one LAN cable to each logger are needed in order to simultaneously configure multiple devices.
(The LAN1 port is used for configuring the instrument's settings, even when using UDP output.)



LAN Cable 9642
Straight-through LAN with crossover conversion connector, 5 m (16.4 ft.)

Please see page 7 for a conceptual connection diagram.

Step 5 **Choose how to output data**

- **Output data from LAN1**
There's no need to provide additional LAN cables as described in Step 4.
- **Output data from LAN2** LR8102 only
An additional LAN cable is required if you wish to output data from the LAN2 port. Use of Cat 7 cabling is recommended since large amounts of data will be transferred at high speed.
- **Output data from CAN** LR8102 only
One CAN cable is required for each logger.
 **CAN Cable 9713-01**
With one end terminating in bare wires; length: 1.8 m (5.9 ft.)

Step 6 **Synchronize measurement** LR8102 only

If you wish to synchronize measurement of multiple loggers, you'll need one optical connection cable for each logger. Choose either the L6101 or the L6102 based on the required length.



Optical Connection Cable L6101
Length: 1 m (3.3 ft.)

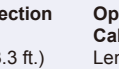

Optical Connection Cable L6102
Length: 10 m (32.8 ft.)

Logger options: Power supply, synchronization cable



AC Adapter Z1016
Powers the logger using commercial power (AC power)



Power Cable L1012
With one end terminating in bare wires, approx. 2 m (6.6 ft.)
Powers the logger using an external power supply (DC power)



For synchronizing measurement of multiple loggers

LR8102 only

Optical Connection Cable L6101
Length: 1 m (3.3 ft.)

Optical Connection Cable L6102
Length: 10 m (32.8 ft.)



For CAN output

LR8102 only

CAN Cable 9713-01
With one end terminating in bare wires; length: 1.8 m (5.9 ft.)



LAN Cable 9642
Straight-through LAN with crossover conversion connector, 5 m (16.4 ft.)

Logger option: measurement

Logger option: Storage media

Be sure to use storage media supplied by Hioki. Instruments may not be able to write to or read from storage media other than Hioki media; proper operation not guaranteed.



SD Memory Card Z4001
2 GB





SD Memory Card Z4003
8 GB



USB Drive Z4006
16 GB

Sensors

For reference only.
Please purchase locally.

K Thermocouple T Thermocouple

Note: Company names and product names appearing in this brochure are trademarks or registered trademarks of various companies.



DISTRIBUTED BY

HEADQUARTERS
81 Koizumi,
Ueda, Nagano 386-1192 Japan
<https://www.hioki.com/>

