

A Brief History of the Micrometer



Mitutoyo

A Brief History of the Micrometer

Copyright © 2008 by Mitutoyo America Corporation

Published by

Mitutoyo America Corporation

965 Corporate Blvd.

Aurora, Illinois 60502

Phone: (630) 820-9666

Fax: (630) 978-3501

Email: info@mitutoyo.com

www.mitutoyo.com

All rights reserved. No part of this publication may be reproduced, stored in a retrieval system, or transmitted, in any form or by any means, electronic, mechanical, photocopying, recording or otherwise, without prior permission of the copyright owner.

Printed November 2008

Contents

Foreword	2
History of Machine Tools and Micrometers	4
Chapter I: The Early Period	6
Threads Used in Linear Measurements	
First Attempt to Measure Length with Threads	6
Watt's Tabletop Micrometer	7
"Lord Chancellor" by the Father of Machine Tools	8
The First Commercial Measuring Machine	9
Chapter II: The Bronze Age	10
Creating the Basic Design of a Micrometer	
The Birth of the Modern Micrometer	10
Born in France, Raised in America	11
Micrometers for Plate Thickness Measurements	12
Micrometers for All Applications	13
Chapter III: The Rise of Industry	14
Progress in Japan	
Expanding Technologies in Japan	14
Domestic Manufacturers Start R & D	15
Micrometers by Mitutoyo	16
Micrometers During the War	17
Chapter IV: Rise of "Made in Japan"	18
Period of Worldwide Expansion	
Hardships During and After the War	18
From Reconstruction to Mass Production	19
Innovations to Meet Industry Needs	20
Maturity Through Intense Competition	21
Chapter V : A Partner of Information System	22
Moving into the Silicon Age	
From Reading Graduations to Looking at a Display	22
Advancements in Digital Displays	23
Merits of Data Output	24
Completing a Full Circle	25
Chapter VI: The Future of Micrometers	26
The Next generation of micrometers	
A Revolutionary Advancement in Micrometer Technology	26
Pioneering Design: 2mm Feed Per Revolution	28
Index	30

▣ Foreword

Over 4.6 billion years ago, Planet Earth was formed. Our distant ancestors debuted only 5 million years ago. Though primitive, they were believed to have used stones as tools. A scant 500 thousand years ago, modern man (*homo sapiens*) roamed the land. Today, their descendants use tools to build large structures, design high speed vehicles, and manufacture microscopic parts too small for the human eye to see.

Making this possible are fabricating devices called Machine Tools. Also known as the 'Mother Machine', they are one of the foundations of industrial progress. Originally created to meet the manufacturing needs of watchmakers, their use has extended to all aspects of manufacturing.

To meet and ensure design specifications, it was necessary to incorporate measuring instruments into the production

line. As Machine Tools grew to become one of the essential elements of the manufacturing industry, so did the accompanying measuring instruments such as the Micrometer.

Invented in the 18th Century, the Micrometer was initially bulky and restricted to the tabletop. Over time, newer models became compact enough to be operated by one hand and still provide outstanding measuring accuracy.

This booklet covers the birth and evolution of Micrometers: tools essential to the progress of modern industry.



History of Machine Tools and Micrometers

Year	Micrometers	Industry and Machine Tools
BC period	c.200BC Screw thread invented	c.300BC Oldest turning machine found in Egypt
Before 1600		15th Century Leonardo da Vinci proposed lathe 16th Century Gear-cutting machine developed
17th Century	1639 W. Gascoigne invented a micrometer caliper comprising of jaws and scale	1638 W. Gascoigne utilized screw threads to observe stars. The first recorded application of screw threads
18th Century	1772 J. Watt invented the table-top micrometer	1713 J.Maritz invented the vertical boring machine 1763 Pertherwood invented a special turning machine to cut threads on cylinder surfaces 1765 J. Watt granted a patent for the steam engine 1775 J. Wilkinson invented a boring machine to cut internal cylinders, contributing to increased power of steam engines.
19th Century	1805 H. Maudslay invented the table-top micrometer called 'Lord Chancellor' 1848 J. Palmer received a patent for his micrometer called 'Palmer System' in France 1855 J. Whitworth invented a horizontal calibration machine and made it available for sale 1868 Brown & Sharpe invented pocket-sized micrometers for measuring plate thicknesses	c.1800 H. Maudslay, the father of machine tools, invented reciprocating gear-cutting lathe 1827 E. Whitney invented the horizontal milling machine 1830 B. Thimonnier invented the sewing machine 1838 R. Buchanan invented the radial boring machine

Year	Micrometers	Industry and Machine Tools
19th Century	<p>1877 Victor Machine placed an ad for their micrometer in the inaugural issue of American Machinist</p>	<p>1876 N. Otto invented the combustion engine</p>
20th Century	<p>1920 ~ 1935 Several Japanese manufacturers start producing micrometers</p> <p>1938 Mitutoyo starts producing Micrometers</p> <p>1947 Mitutoyo restarts producing Micrometers after WWII</p> <p>1953 Mitutoyo produced the 3 meter outside micrometer, the largest in the world</p> <p>1969 Mitutoyo started producing 3-pointed inside micrometers</p> <p>1979 First digital Micrometer in Japan introduced by Mitutoyo</p>	<p>1903 Wright brothers succeeded in their first flight</p> <p>1907 H. Ford introduced the Model T, the first car to be mass-produced</p> <p>1941 US suspends export of machines to Japan</p> <p>1952 MIT produced first NC milling machine</p> <p>1956 Fanuc produced the NC turret punch press machine, the first in Japan</p> <p>1958 US Kerney Trecker produced first machining center</p> <p>1982 Japanese machine tools are recorded as the largest in terms of value in the world</p>
21st Century	<p>2003 Mitutoyo introduced its first coolant-proof micrometer</p> <p>2004 Mitutoyo introduced its improved ratchet-thimble micrometer</p>	<p>2001 Kyoto Protocol to reduce the emission of greenhouse gases completed</p> <p>2006 Japanese Machine tool industry achieved the largest annual sales worth \$14.3 billion, exceeding 1990 records</p>

Chapter I: The Early Period

First Attempt to Measure Length with Threads

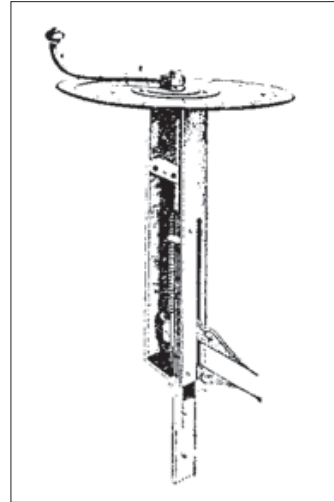

H. Gascoigne's Micrometer Caliper

Measurement started as early as 5000 years ago when the Egyptians built the Pyramids.

The principle of screw threads was used by the Greeks to raise water from a lower to a higher level. The idea of using these same threads for measurement did not exist then.

It was during the 17th century when threads were utilised to measure the length of objects. In 1638, the English astronomer W. Gascoigne used the principle of threads to measure the distance of stars. Fine-adjusting his telescope by screw threads, he measured the stars in the nightly sky. However in this method, he did

not use threads to directly measure the objects. Nevertheless, his method of measuring distances by thread displacement was similar to modern methods.

In the following year, he invented a measuring gage called the "Caliper Micrometer". The system comprised of a rotating handle attached to the end of a threaded rod connected to a movable jaw. A reading was achieved by counting the revolutions of the handle against an attached disc. The disc divided one rotation into 10 equal parts, thus he could measure the distance covered by the moving jaw with accuracy.

Threads Used in Linear Measurements

Watt's Tabletop Micrometer

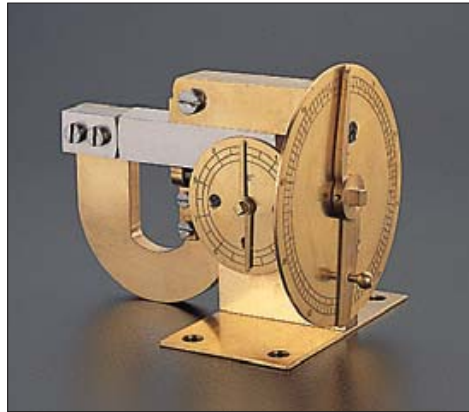

James Watt's Tabletop micrometer (replica)

More than a century after Gascoigne invented his measuring instrument, James Watt of the steam engine fame invented the first bench-type micrometer. A key concept of his design was magnification based on threads. In all history books, his name is always mentioned, and with good reason: Without Watt, a history of micrometers cannot be written.

His invention, briefly described, consists of a rack-and-pinion mechanism connected to rotating threads. In practice, a measuring blade attached to the rack advances and makes contact with an object to be measured. The movement of threads was measured by a pair of graduated discs attached to the end of the

threads. The larger graduated disc indicates revolution of threads, while the smaller one indicates fractions of an inch. The smallest reading on the large dial face was $1/10000$ of an inch.

At the time, gages were generally large and cumbersome to operate, and for that reason his gage was designed to be used on a workbench.

James Watt was the first to employ a "U"-shaped frame, and can be recognised as a standard design for modern micrometers. However, for a long period of time following Watt's invention, the "U"-shaped frame was not used, and micrometers using this design did not appear in the market.

"Lord Chancellor" by the Father of Machine Tools

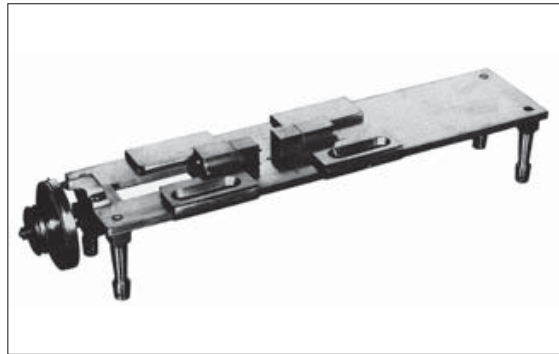

Maudslay's "Lord Chancellor" a table-top micrometer

In the early part of the 19th century, Sir Henry Maudslay was known as "The Producer of Best Machine Tools" in London.

His screw-cutting lathe invented circa 1800 was said to be the origin of modern Machine Tools. Moreover, he produced a dedicated machine to mass manufacture pulleys used in sailing ships. He also conceived the idea of modern machine shops, and provided input for the development of surface grinders and milling machines.

He was well respected in England and was called the "Father of Machine Tools". In the field of machine tools, Maudslay's name is held in

high regard, second only to Leonardo da Vinci.

Maudslay also left his mark in measuring instruments. His table-top micrometer, called "Lord Chancellor", was the most precise of that day and considered as the beginning of precision measuring instruments.

It was a brass four-legged table-top device about 40cm long, and featured a pair of blocks to sandwich objects. Below the saddle was an opening, and to its edge were 1/10000 inch graduations. It was so precise that it was retested years later in 1918 and was still found to be accurate.

Threads Used in Linear Measurements

The First Commercial Measuring Machine

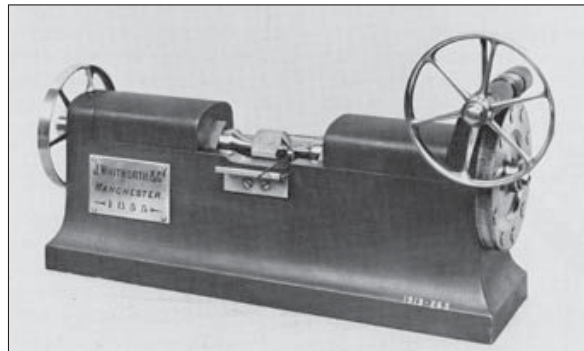

Whitworth's "Millionth of an inch" measuring machine

James Watt and Maudslay's tabletop micrometers were largely limited to private use. It was only during the later part of the 19th century that precision measuring machines were made available for sale.

It was Sir Joseph Whitworth who introduced one of the most remarkable instruments of that period: his "millionth of an inch" ($0.254\mu\text{m}$) measuring machine, many of which were sold to the general public. Today, a 1.8 meter-long Whitworth measuring machine is displayed at the Mitutoyo Museum.

Sir Whitworth was one of the giants in engineering after Maudslay: He was

well known for the threads bearing his name—Whitworth Thread. Whitworth was also excellent in managing machine shop operations. He also created a method to make flat surface plates, and simplified maintenance by using standardized screw threads. He always experimented and tested a prototype, and his decision was based on supporting data. His knowledge aided in streamlining manufacturing operations and establishing analytical control systems.

He was a frontrunner in the mid 19th century and his contributions left an indelible mark in the development of Machine Tools.

Chapter II: The Bronze Age

The Birth of the Modern Micrometer

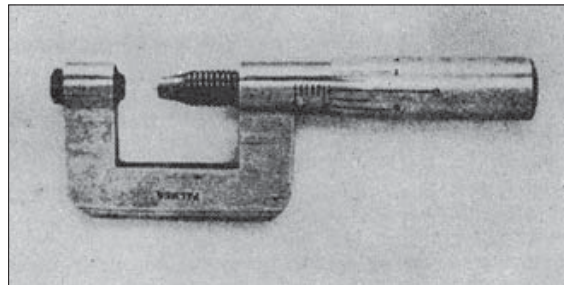

Palmer's Micrometer displayed in Paris

Today's standard Micrometer features a "U"-shaped frame and one handed operation. Many manufacturers share this common micrometer design. The origin of this design can be traced back to the French inventor J. Palmer who received his patent in 1848. It was called the "Palmer System".

As stated earlier, using screw threads for measuring linear distances has its origin in Gascoigne's invention in 1638. Essentially, Palmer used the same principle in his compact hand-held micrometer. However, his design was more advanced and marked the beginning of modern micrometers. Palmer's contribution was immeasurable in the history of the micrometer.

Modern micrometers closely follow the Palmer System's basic design of a "U"-shaped frame, thimble, sleeve, spindle, anvil, etc. The reading edge of the thimble was slightly tapered down to meet the graduations on the sleeve. The circumference of the thimble was divided into 20 equal parts, thus providing accuracy of up to 0.05mm.

Brown and Sharpe of B&S Co. visited the International Exposition in Paris in 1867. It was there that they both witnessed the Palmer System for the first time and made the decision to bring it back to America. This encounter in Paris led to a successful introduction of micrometers across the Atlantic.

Creating the Basic Design of a Micrometer

Born in France, Raised in America



The Palmer System brought back to America by Brown and Sharpe was not perfect in workmanship. It employed 1mm pitch threads and was accurate up to 0.05mm. While the drawings of Palmer's patent application were carefully rendered, the design could be improved. For example, it offered no spindle clamp. More importantly, the graduated lines were not equally spaced.

However, Brown and Sharpe did not pay attention to these minor imper-

fections: they could improve upon the original design by replacing it with a finer 40 threads per inch spindle.

The Palmer System was brought across the Atlantic by two American entrepreneurs, and it was in America where improvements in micrometer design took place in earnest. It was the countless new innovations added to it in America that made the micrometer so popular today. The modern micrometer was truly born in France and raised in America.

Micrometers for Plate Thickness Measurements

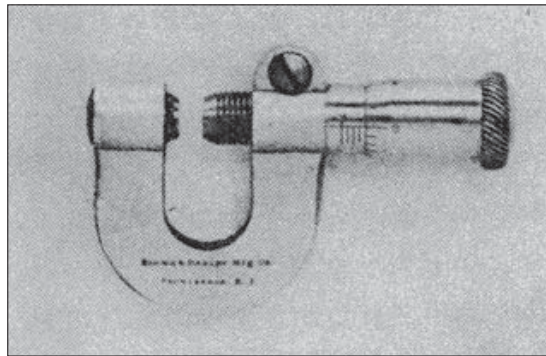

Brown & Sharpe's pocket micrometer for plate thickness

Micrometers were needed in America for a good reason: Manufacturers and customers could not agree on the thickness of brass plates, due to the fact that they each used their own special gages to take their readings.

The chief inspector of Bridgeport Brass Plate Company was S. Wilmot. He produced six trial gages whose design was influenced by the table-top micrometer produced by a company in New York. It was Wilmot who presented one of his prototypes to the Brown and Sharpe Company, and suggested that they market it for general use.

The appearance and principles

used in the prototype were close to what a micrometer should be. However, the reading of dimensions was complicated. The operator was required to interpret the measured values based on the meeting point of the lines. This design proved to be unsuccessful.

Brown and Sharpe studied the micrometer they brought back from Paris, and added two features: a mechanism to hold spindle threads better, and a spindle clamp. Their tiny pocket-type micrometer was produced in 1868 and introduced in the market the following year.

Creating the Basic Design of a Micrometer

Micrometers for All Applications

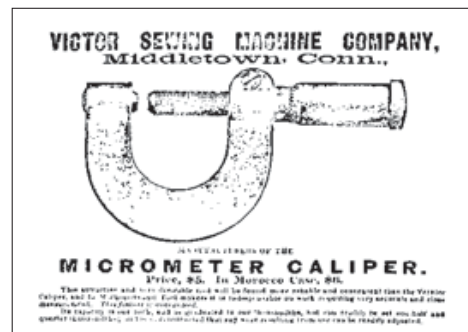

Micrometer Caliper Introduced by Victor Machine Co.

Brown and Sharpe correctly surmised that micrometers would be a necessity in all machine shops. In 1877, nearly 10 years after their tiny pocket-type micrometers debuted, Brown and Sharpe produced their first 11 inch outside micrometers (accurate to 0.001 inch or 0.0254 mm). It took them a long time to reach this point.

The inaugural issue of *American Machinists* in November 1877 carried an advertisement placed by Victor Machine Co., announcing a new micrometer made in America. There was no advertisement placed by Brown and Sharpe.

It appeared that both Brown and

Sharpe and Victor Machine had developed micrometers almost simultaneously. At this period in America, the sewing machine was soon to become a popular product. To manufacture parts and components for sewing machines more precisely, the micrometer was a must.

Regardless of which company was the first to introduce it to the market, both companies ensured that they were widely available. Micrometers were now used in machine shops to improve product quality. It was the efforts of these companies to mass-produce and promote micrometers that deserves recognition.

Chapter III: The Rise of Industry

Expanding Technologies in Japan



Textile factory in the 1910s (Source: Gunze)

In Japan, the aspiration to become a "nation of power and technology" emerged during the Meiji period. This spirit was further enforced during the Taisho and Showa periods that followed. Consistent with this direction, the Japanese government also helped bring advanced foreign technologies into Japan, supporting the growth of its domestic industries. The Army, Navy and Air Force, together with the Railroad Ministry also pushed industrialisation in Japan.

With this as a backdrop, a move to create domestic companies dealing in advanced industries such as machine tools and measuring instruments started. To help in this process, government organizations helped import products from overseas and assisted in creating

prototypes. With this support, domestic manufacturers in Japan were ready to produce products themselves.

Such companies started by taking foreign-made products and creating their equivalents domestically. In the process, they acquired technical know-how and created production techniques suitable for their own situation.

At the time, the domestic industry was dominated by textile production. The production of airplanes and cars for military use only just started. The consumption of tools increased in tandem with the push for industrialization.

After the Manchurian Incident, the production of airplanes accelerated which in turn boosted the need for machine tools and measuring instruments of all kinds.

Domestic Manufacturers Start R & D



Model of Early Mitutoyo factory in Kamata, Tokyo

The first use of a micrometer in the factory in Japan was at the end of the Meiji period. At the time, it was limited to a handful of companies. With the use of micrometers, they were able to measure products more accurately and quickly. As a result, there was a significant drop in rejected products.

Imported micrometers were limited in number. Some companies tried to make micrometers themselves. The first attempt was not recorded and there is no way to tell whether it was a private or military organization. It is also impossible to tell when this move first

started in Japan.

According to the official record, Sonoike Manufacturing Co., then the best known machine tools and fixture maker, made a prototype micrometer in 1918. They made it based on C. E. Johansson's model. In 1921, Sonoike Mfg. Co. participated in a machine tool show organized by the government, displaying inch and metric micrometers as well as micrometer heads.

Shortly after 1929, Tsugami Mfg. Co. and from 1931 through 1934, Mitutoyo, Mitsuseiki, NSK, Fujikochi, started R&D work on micrometers.

Micrometers by Mitutoyo



First Mitutoyo Micrometer



Promotional towel distributed nationwide

Mitutoyo was among the group of manufacturers that started to work on micrometers in the early period. Its founder, Yehan Numata, purchased a small lot in Kamata, Tokyo, in 1934. He started his R&D efforts, hoping to introduce his micrometers one day. Three years later, after countless trial-and-error attempts, he finally produced the first Mitutoyo micrometer for sale.

Their first commercially available micrometer was produced in 1937. To promote the first lot of micrometers, a special promotional towel was prepared. On it was a slogan: "Good, Inexpensive and Long Lasting: The World's

Best Micrometer".

The leading principles of his company were "Good Environment, Good People, and Good Technology". Having led his small group, he understood the importance of the mindset of his coworkers. Yehan Numata believed that good people could be raised in a good working environment.

In order to manufacture products trusted by users, he knew that the process of educating his coworkers was essential. A concept of raising good people first before making products is not new today. This approach at Mitutoyo started over 70 years ago.

Progress in Japan

Micrometers During the War



Battleship Yamato under construction (Source: Yamato Museum)

Micrometers made in Japan became available from several sources. However, not many of them received the level of trust they had expected. It was difficult to manufacture micrometers without prior experience. It was equally difficult to have them accepted by users who preferred imported brands.

Meanwhile, the nation started to prepare for war in 1941. Demand for micrometers increased along with increased production of war materials such as guns, battleships and airplanes. As imported goods were restricted, the military government authorised Mitutoyo to continue the production of micrometers. This production was carried out until the end of the war.

This is not well known, but the first serious attempt to manage production processes in Japan started

with the Yamato, the largest battleship ever built. Comprehensive planning was needed to produce a battleship as large as the Yamato in a narrow shipyard, and make it seaworthy by the set deadline. Necessary components, often extremely large, must be delivered to the specified location on the specified day to make the best use of a limited-space dry dock. To overcome this enormous task of building the largest battleship, it was necessary to standardize components and parts. As a result, the "Just-In-Time" method was formulated out of necessity.

The road to standardization started here, and years later this process was adopted in production and quality control. In short, the Battleship Yamato was the roots of modern production methods in Japan.

Chapter IV: Rise of "Made in Japan"

Hardships During and After the War



Private citizens supporting the war efforts

Throughout the WWII period and even thereafter, the production of micrometers encountered enormous difficulties. A nation engaged in war required micrometers to produce high accuracy and high quality war materials such as tanks, battleships, airplanes, guns and ammunition. However, micrometers were in short supply.

Meanwhile, so called ABCD-line allies stopped all shipments of essential raw materials. This aggravated an already short supply of raw materials for the metalworking industry. To produce a less than perfect product or to create waste was not toler-

ated. Skilled engineers and workers had gone to the battlefields, leaving behind the young, the old, and the womenfolk.

Then came the end of WWII. All major cities had been burned to ashes, and Mitutoyo's Kamata Factory was no exception. The adjacent Mizonokuchi Factory ceased to operate and closed its doors. With only a few security personnel to guard the property, the entire operation was closed.

Later, soldiers from overseas returned to their homeland. The nation awoke to a different world, and slowly started to rebuild itself.

Period of Worldwide Expansion

From Reconstruction to Mass Production



Conveyor-belt line during the 1960s

Reconstruction of a nation had begun. But basic items such as food, clothing, and living necessities had to be provided for first. It took a while for measuring gages to make a comeback. Nevertheless, in October 1947, Mitutoyo restarted production of micrometers and in 1949 it was ready for full production.

In the international scene, polarization of two major powers was established and war broke out in the Korean Peninsula. The US military personnel stationed in Japan moved quickly to Korea. In so doing, they turned to Japan for military materials, thus igniting a round of economic activities which revived the metalworking industry.

By the 1950s, domestic demand for consumer goods such as televisions and cars had increased and gave momentum to the manufacturing sector. Against this backdrop, mass production had started, and in the process stimulated the economy in Japan. To achieve the goals of a large scale production, all parts must be made within much tighter tolerances. Statistical Process Control to manage production runs and rational approaches in manufacturing took the centerstage during this period.

A trend toward tighter size control was not limited to mass-produced parts. In shipbuilding and in steel mills, micrometers were also used to validate specifications.

Innovations to Meet the Needs

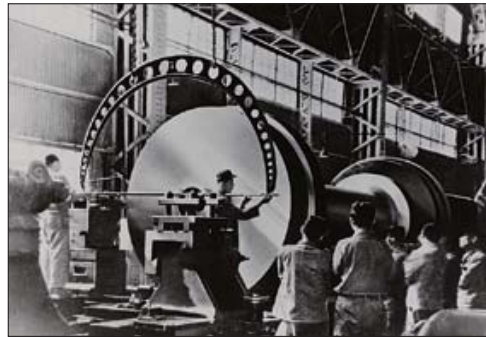

Extra large micrometer for heavy industry

As the manufacturing sector in Japan regained its strength, the areas of application where a micrometer could be used increased steadily. The measuring range of micrometers also increased significantly. For example, in 1953 a micrometer capable of measuring a 3 meter diameter was produced and sent to a shipbuilder to measure a shaft.

By taking into account user feedback on micrometer specifications, the quality of Made-in-Japan micrometers reached a point where they were acceptable to overseas customers.

Some of the improvements made were:

- 1: Satin-chrome finished thimble, sleeve, and frame: Improved contrast of graduated lines and assured longer tool life.
- 2: Friction Thimble: In addition to the standard ratchet stop, this feature was added to provide constant pressure, making it easy for an operator to use it with one hand.
- 3: Hardened and ground spindle threads to achieve higher accuracy and durability.
- 4: Carbide-tipped measuring faces for more precision and durability.
- 5: The conventional ring clamp was redesigned to a lever-type spindle clamp.
- 6: Special-purpose micrometers for threads and other forms were produced.
- 7: Mechanical type digital counter was added to standard micrometers.

Period of Worldwide Expansion

Maturity Through Intense Competition



Micrometer bearing "Made in Japan"

During the WWII and a few years thereafter, the quality of "less than perfect" micrometers started to improve dramatically due in part to the rising demands of end-users. Research and development had also begun to discover materials that would not be affected significantly by variations in temperature. Another area of research during this period was to find a new way to cut spindle threads - the heart of the micrometer.

The quality improvement of micrometers was one thing, but containing manufacturing costs was another. In spite of that, Mitutoyo's micrometers gradually became comparable to foreign counterparts and started to

surpass them in quality and price. All told, "Made in Japan" products started to be accepted by customers in many countries, and the micrometer was no exception. Behind all this was a series of improvements that took place in areas such as materials, manufacturing methods, assembly, and process control. Surviving through intense competition, Mitutoyo established itself as a leader in high-tech micrometers.

Innovations in electronics changed the way all measuring instruments were perceived: The emphasis had shifted from reading graduated lines to glancing at LCD displays. The advent of electronics gave rise to a new breed of micrometers.

Chapter V : A Partner of Information System

From Reading Graduations to Looking at a Display



Digital Micrometers (mechanical and electronic models)

The bulky table-top micrometers of the past had been completely transformed into a much simpler and easier gage to handle on the shop floor. A revised micrometer frame allowed it to reach areas once inaccessible by old models. Not long ago, machinists needed to take time to carefully read and interpret line graduations. Everyone understood that one must pay attention in the reading process. If a micrometer was used only a few times a day, it would not matter; but if the reading should be repeated tens and hundreds of times a day, the process of reading micrometers became very time consuming. Moreover, operator fatigue would cause reading errors.

It became necessary for standard micrometers to be redesigned to show measured dimensions in digits — a move from reading graduations to looking at LCD display.

Earliest models were based on mechanical digital counters. Those were capable of resolutions up to 1/100mm. With the advent of LED/LCD, 7-segments, and other innovations, micrometers were given a chance to incorporate what the latest in microchip technology offered. Thus, Digital Micrometers based on electronics became a standard.

It opened up a potential area where micrometers might still be improved in view of a total measurement system.

Advancements in Digital Displays



Introducing Count Micrometers

Reading a micrometer is a delicate operation: machinists are trained to add one revolution to a micrometer reading depending on how many turns the thimble has turned. For example, a thimble reading may suggest either 8.23mm or 8.73mm. This decision must be made by looking at the sleeve more intently — a process of learning how to read a micrometer.

The introduction of the digital micrometer eliminated this possible reading error, and became the preferred system for all users the world over. The advertisement above introduces a new model called the "Count Micrometer". This feature was added to all models to make readings fast and accurate. However, the classic line graduated models were still produced

because many seasoned machinists didn't need the digital counter. They were also not satisfied with the limitation of an accuracy of only 1/100mm. They demanded a finer digital resolution of 1/1000mm (1 μ m). The birth of microchips and LSIs has also changed the industry, and demand steadily increased for these higher accuracy micrometers.

The first LCD digital model with a resolution of 1/1000mm offered by Mitutoyo required three batteries and was rather heavy. One noteworthy feature on this early model was a plug-in connector to send data to other devices.

Merits of Data Output

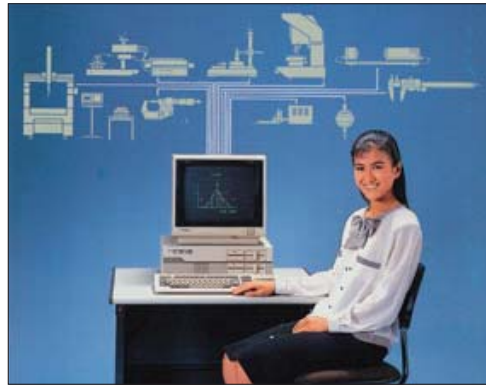

Overview of a Quality Control System (in 1987)

NC Machines and automation in the field of machine tools revolutionised the traditional method of production. In larger factories, total control systems were deployed through computer technology where data is stored and shared by many users. This required a flexible system of control to cope with a wide variety of products produced in small lots.

In this day and age where dimensional tolerances are much tighter and the products manufactured are more complex, quality control and production methods must also be evolved from a single point of measurement to multi-faceted operations. In so doing, the expectations for a gage has

also changed from a simple hand-held micrometer to an input device for a total information system.

In the manufacturing sector, the ultimate goal of information technology is to build a climate of shared data throughout the entire organisation. With this in mind, Mitutoyo's digital micrometers feature an output port for downloading so that creating SPC and other reports are easily done.

This approach leads to the prediction of controlled dimensions and avoidance of potential hazards in quality control. With this line of thought, Mitutoyo is at the cutting edge of technology.

Completing a Full Circle



Ads for Digimatic products

Large and medium size companies aim for consolidation of all data in plant operations, from materials to quality control, and from initial design stage to the final product. Not all manufacturing operations are alike in the pursuit of their goals. The majority of medium-to-small companies in Japan do not need such a comprehensive system in quality control.

Some users pay more attention on how to maximise the value of a single micrometer. Those who are in this group demand compactness, long-lasting battery life, waterproofing and low cost; all of which are reasonable and realistic requests. A product cannot achieve the status

of the "very best" in its intended field without accommodating requests raised from all levels of users. In the process of product planning, engineers must look at the market through a lens resembling a compound eye.

From the outset, only a handful of companies started making micrometers, and were joined by nearly a dozen more in Japan. Emerging from this, the winner was Mitutoyo, which has been producing micrometers for over seventy years. It produces literally hundreds of types of micrometers for every conceivable purpose. Behind all this is a spirit of putting the users' needs first.

Chapter VI: The Future of Micrometers

A Revolutionary Advancement in Micrometer Technology

QuantuMike



Range: 0~25mm
Resolution: 0.001mm



Range: 25~50mm
Resolution: 0.001mm

A brief history of the micrometer has been presented in the preceding chapters. For all micrometers, the core element of magnification was the screw threads that transformed minute linear displacements into larger areas represented by the thimble. The accuracy of the threads dictated the accuracy of a micrometer.

Since the early days, micrometers employed 0.5mm pitch threads (.025in. for inch models), which took 50 revolutions to travel from 0 to 25mm. Proportionally, it would move twice as fast if a 1mm thread pitch was used. Such micrometers are also

available. However, the thimble would also need to accommodate 100 lines on its circumference, which would result in a far larger thimble. This would negatively affect one handed operation of a micrometer. To keep it within a reasonable size, space between the graduation lines must be made narrower, even though it may be harder to read.

The new Mitutoyo QuantuMike introduced in 2007 is based on a 2mm thread pitch — moving four times faster than the conventional designs. This unique configuration has never been attempted before.

Mitutoyo QuantuMike



A Revolutionary Advancement in micrometer technology

Mitutoyo unleashes the next generation of micrometers, delivering unsurpassed performance since the innovation by James Watt in 1772. Thanks to the integration of sophisticated manufacturing and cutting-edge technology from Mitutoyo, the QuantuMike far exceeds users' expectations.

The name QuantuMike is derived from 'Quantum' and 'Micrometer', reflecting our belief that this tool represents a quantum leap in micrometer ergonomics.

Pioneering Design: 2mm Feed Per Revolution



Measuring coaxial workpiece

All conventional micrometers require 50 revolutions per 25mm. With 2mm screw threads, the new QuantuMike moves four times faster, thus making it much easier to operate. A little known fact: after a square workpiece is measured, the spindle must be rolled back to disengage it. A short twist backward on the new QuantuMike will allow this step to be completed quicker. The secret is in the unique, patented 2mm pitch threads design — another first by Mitutoyo.

Another significant technological feature of the QuantuMike is its high-resolution. Conventional digital micrometers based on 0.5mm pitch threads subdivide one revolution of the spindle into 500 equal parts, thus reading to 0.001mm (1 μ m) resolution. To provide the same reading for the four-times-faster QuantuMike, one spindle rotation must be divided into 2000 equal parts. For this reason, Mitutoyo developed a new disc encoder technology and is the first to achieve this goal.

The Next Generation of Micrometers

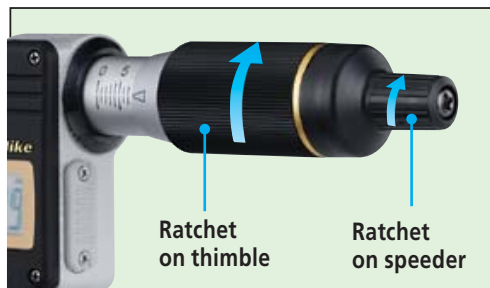

Ratchet-induced microvibrations ensure repeatable measurements



Proven waterproof

The QuantuMike is also enhanced with the following features:

Repeatable measurement

The patented ratchet thimble mechanism helps ensure repeatable results by transmitting microvibrations along the spindle to the contact face to provide a constant measuring force and encourage good contact with the workpiece. The ratchet works from the thimble as well as the speeder so it is always easy to use - even when making measurements one-handed. The sound of the ratchet provides the user with a sense of confidence and the speeder enables the rapid spindle feed needed when meas-

uring widely different dimensions.

Function lock helps prevent error

QuantuMike is equipped with a function lock feature to prevent the origin point being moved by mistake during measurement.

Dust/water resistance with IP65 protection level

Excellent resistance against oil, water and dust enables this product to be used in machining situations that include splashing of coolant fluid.

The new QuantuMike is a breakthrough in the history of micrometers. This is what all future micrometers should be.

Index

A

American Machinists 13

B

B&S Pocket-type Micrometer 12
Bridgeport Brass Plate Co. 12
Brown and Sharpe 10, 11, 12, 13

C

Caliper Micrometer 6
Count Micrometer 23

D

Digital Micrometers 22

F

Father of Machine Tools 8

G

Gascoigne, W. 6

J

Japan
 First Micrometer 15
 Foreign Technologies 14
 Industrialisation 14
 World War II 17
Johansson, C. E. 15
Just-In-Time method 17

L

Lord Chancellor 8

M

Machine Tools 2, 3
 History 4
Mass Production 19
Maudslay, H. 8
Micrometer
 "U"-shaped frame 7, 10
 3 Meter Diameter 20
 Dust/water Resistance 29
 Function Lock 29
 High-Resolution 28
 History 4
 Japan 15
 LCD display 22
 Made in Japan 20, 21
 Mechanical Digital Counters 22
 Modern 10
 One Handed Operation 10
 Plug-in Connector 23
 Reading Error 23
 Repeatable Measurement 29
Micrometer Caliper 13
Millionth of an Inch Measuring
Machine 9
Mitutoyo
 First Micrometer 16
 Leading Principles 16
 QuantuMike. See QuantuMike

N

NC Machines 24
Numata, Y. 16

P

Palmer's Micrometer 10
Palmer, J. 10

Q

Quality Control System 24
QuantuMike 26, 27, 28
Features 29

S

Screw Threads 26
Magnification 7
Principle 6
Sonoike Manufacturing Co. 15
Statistical Process Control 19
System Palmer 10, 11

T

Tsugami Manufacturing Co. 15

V

Victor Machine 13

W

Watt's Tabletop Micrometer 7
Watt, J. 7
Whitworth, J. 9
Wilmot, S. 12
World War II 17, 18

Y

Yamato, Battleship 17

Mitutoyo North America Operations



● **Mitutoyo America Corporation**
 ■ **Corporate Headquarters**
 Aurora, Illinois USA
 (630) 820-9666



● **Mitutoyo Canada Inc.**
 ■ **Corporate Headquarters**
 Mississauga, Ontario Canada
 (905) 821-1261



● **Mitutoyo Mexico**
 ■ **Corporate Headquarters**
 Estado de Mexico, Mexico
 (0155) 5312-5612

Mitutoyo America Corporation

Established in 1963, Mitutoyo America Corporation has locations all across the US and Canada, including corporate offices, sales offices, M³ Solution Centers, calibration and repair laboratories, and research and development facilities. Mitutoyo America offers a full product line of precision measuring tools, instruments and equipment. Mitutoyo provides a comprehensive metrology organization, with dependable product and technical support, state-of-the-art calibration and repair services, unmatched education and training programs and cutting-edge research and development. As the leading metrology company in the world, Mitutoyo is committed to future product development that applies breakthrough technologies to its full range of dimensional measurement tools, instruments and systems. With the belief that providing high quality metrology goods and services to its customers will in turn, allow its customers to provide high quality product to theirs, Mitutoyo continues to develop the most advanced and sophisticated metrology equipment available. "Precision is our profession" is not just the company motto, but also the principle by which every Mitutoyo employee stands when serving our customers.





Aurora
 945 Corporate Blvd
 Aurora, IL 60502
 (630) 978-5385



Aurora
 958 Corporate Blvd
 Aurora, IL 60502
 (630) 978-5385



**Elk Grove Village
 Calibration Lab**
 2025 Tonne Road
 Elk Grove Village, IL 60007
 (847) 593-7750



M³ Solution Center

Mitutoyo Tools and instruments can be seen and demonstrated conveniently at any one of nine Mitutoyo M³ Centers nationwide. These centers are fully equipped featuring operational models of the latest Mitutoyo tools and instruments. By appointment or walk-in basis, product demonstrations at M³ Solution Centers are carried out by our experienced, highly trained staff. Contact your Mitutoyo distributor or the Mitutoyo regional office near you for more information.



Boston
 1 Park Drive, Suite 11
 Westford, MA 01886
 (978) 692-8765



Los Angeles
 16925 East Gale Ave.
 City of Industry, CA 91745
 (626) 961-9661



Charlotte
 11515 Vanstony Drive, Suite 150
 Huntersville, NC 28078
 (704) 875-8332



Seattle
 11533 NE 118th Street, Suite 200
 Kirkland, WA 98034
 (626) 961-9661



Cincinnati
 6220 Hi-Tek Court
 Mason, OH 45040
 (513) 754-0709



Toronto
 2121 Meadowdale Blvd
 Mississauga, Ontario Canada
 L5N 5N1
 (905) 821-1261



Detroit
 45005 Five Mile Road
 Plymouth, MI 48170
 (734) 459-2810



Montréal
 7075 Robert-Joncas Place, Suite 129
 Montreal, Quebec Canada
 H4M 2Z2
 (514) 337-5994

Coordinate Measuring Machines

Vision Measuring Systems

Form Measurement

Optical Measuring

Sensor Systems

Testing Equipment and
Seismometer

Digital Scale and DRO Systems

Small Tool Instruments and
Data Management

Mitutoyo America Corporation

www.mitutoyo.com

One Number to Serve You Better

1-888-MITUTOYO (1-888-648-8869)

M³ Solution Centers

Aurora, Illinois

(Corporate Headquarters)

Westford, Massachusetts

Huntersville, North Carolina

Mason, Ohio

Plymouth, Michigan

City of Industry, California

Mitutoyo

Precision is our Profession