

Leica Rugby 670/680

User Manual



Version 1.0
English

- when it has to be **right**

Leica
Geosystems

Introduction

Purchase

Congratulations on the purchase of a Leica Rotating Laser product.



This manual contains important safety directions as well as instructions for setting up the product and operating it. Refer to "1 Safety Directions" for further information. Read carefully through the User Manual before you switch on the product.

Product identification

The type and serial number of your product are indicated on the type plate. Enter the type and serial number in your manual and always refer to this information when you need to contact your agency or Leica Geosystems authorised service workshop.

Type: _____

Serial No.: _____

Validity of this manual

This manual applies to the Rugby 670/680 lasers. Differences between the models are marked and described.

Available documentation

Name	Description/Format		
Rugby 670/680 Quick Guide	Provides an overview of the product. Intended as a quick reference guide.	✓	✓
Rugby 670/680 User Manual	All instructions required in order to operate the product to a basic level are contained in the User Manual. Provides an overview of the product together with technical data and safety directions.	-	✓

Refer to the following resources for all Rugby 670/680 documentation/software:

- the Leica Rugby CD
- <https://myworld.leica-geosystems.com>



myWorld@Leica Geosystems (<https://myworld.leica-geosystems.com>) offers a wide range of services, information and training material.

With direct access to myWorld, you are able to access all relevant services whenever it is convenient for you, 24 hours a day, 7 days per week. This increases your efficiency and keeps you and your equipment instantly updated with the latest information from Leica Geosystems.

Service	Description
myProducts	Simply add all Leica Geosystems products that you and your company own. View detailed information on your products, buy additional options or Customer Care Packages (CCPs), update your products with the latest software and keep up-to-date with the latest documentation.
myService	View the service history of your products in Leica Geosystems Service Centers and detailed information on the services performed on your products. For your products that are currently in Leica Geosystems Service Centers view the current service status and the expected end date of service.

Service	Description
mySupport	Create new support requests for your products that will be answered by your local Leica Geosystems Support Team. View the complete history of your Support and view detailed information on each request in case you want to refer to previous support requests.
myTraining	Enhance your product knowledge with the Leica Geosystems Campus - Information, Knowledge, Training. Study the latest online training material or download training material on your products. Keep up-to-date with the latest News on your products and register for Seminars or Courses in your country.

Table of Contents

In this manual	Chapter	Page
1	Safety Directions	6
1.1	General	6
1.2	Definition of Use	7
1.3	Limits of Use	7
1.4	Responsibilities	7
1.5	Hazards of Use	8
1.6	Laser Classification	10
	1.6.1 General	10
	1.6.2 Rugby 670/680	10
1.7	Electromagnetic Compatibility EMC	11
1.8	FCC Statement, Applicable in U.S.	12
2	Description of the System	14
2.1	System Components	14
2.2	Rugby Laser Components	15
2.3	Case Components	15
2.4	Setup	16
3	Operation	18
3.1	User Interface	18
3.2	LCD Display Information	18
3.3	Grade Entry	20
3.4	Elevation (H.I.) Alert, Bump Alert and Smart Slope Functions	21
3.5	Rugby 670/680 Option Menu	23
4	Receivers	25
4.1	Rod Eye 140, Classic Receiver	25
4.2	Menu - Rod Eye 140, Classic Receiver	27
4.3	Rod Eye Basic Receiver	27
5	Applications	29
5.1	Setting Forms	29
5.2	Checking Grades	30
5.3	Entering Grades	31
6	Batteries	32
6.1	Operating Principles	32
6.2	Battery for Rugby	32
7	Accuracy Adjustment	35
7.1	Checking the Level Accuracy	35
7.2	Adjusting the Level Accuracy	36
8	Troubleshooting	38
9	Care and Transport	40
9.1	Transport	40
9.2	Storage	40
9.3	Cleaning and Drying	41

10	Technical Data	42
10.1	Conformity to National Regulations	42
10.2	General Technical Data of the Laser	42
11	Lifetime Manufacturer's Warranty	44
12	Accessories	45
	Index	46

1 Safety Directions

1.1 General

Description

The following directions enable the person responsible for the product, and the person who actually uses the equipment, to anticipate and avoid operational hazards.

The person responsible for the product must ensure that all users understand these directions and adhere to them.

About Warning Messages





Warning messages are an essential part of the safety concept of the instrument. They appear wherever hazards or hazardous situations can occur.

Warning messages...

- make the user alert about direct and indirect hazards concerning the use of the product.
- contain general rules of behaviour.

For the users' safety, all safety instructions and safety messages shall be strictly observed and followed! Therefore, the manual must always be available to all persons performing any tasks described herein.

DANGER, WARNING, CAUTION and **NOTICE** are standardized signal words for identifying levels of hazards and risks related to personal injury and property damage. For your safety it is important to read and fully understand the table below with the different signal words and their definitions! Supplementary safety information symbols may be placed within a warning message as well as supplementary text.

Type	Description
 DANGER	Indicates an imminently hazardous situation which, if not avoided, will result in death or serious injury.
 WARNING	Indicates a potentially hazardous situation or an unintended use which, if not avoided, could result in death or serious injury.
 CAUTION	Indicates a potentially hazardous situation or an unintended use which, if not avoided, may result in minor or moderate injury.
NOTICE	Indicates a potentially hazardous situation or an unintended use which, if not avoided, may result in appreciable material, financial and environmental damage.
	Important paragraphs which must be adhered to in practice as they enable the product to be used in a technically correct and efficient manner.

1.2

Definition of Use

Intended use

- The product casts a horizontal laser plane or a laser beam for the purpose of alignment.
 - The laser beam can be detected by means of a laser detector.
 - Remote control of product.
 - Data communication with external appliances.
-

Reasonably foreseeable misuse

- Use of the product without instruction.
 - Use outside of the intended use and limits.
 - Disabling safety systems.
 - Removal of hazard notices.
 - Opening the product using tools, for example screwdriver, unless this is permitted for certain functions.
 - Modification or conversion of the product.
 - Use after misappropriation.
 - Use of products with recognisable damages or defects.
 - Use with accessories from other manufacturers without the prior explicit approval of Leica Geosystems.
 - Inadequate safeguards at the working site.
 - Deliberate dazzling of third parties.
 - Controlling of machines, moving objects or similar monitoring application without additional control- and safety installations.
-

1.3

Limits of Use

Environment

Suitable for use in an atmosphere appropriate for permanent human habitation: not suitable for use in aggressive or explosive environments.



DANGER

Local safety authorities and safety experts must be contacted before working in hazardous areas, or close to electrical installations or similar situations by the person in charge of the product.

1.4

Responsibilities

Manufacturer of the product

Leica Geosystems AG, CH-9435 Heerbrugg, hereinafter referred to as Leica Geosystems, is responsible for supplying the product, including the user manual and original accessories, in a safe condition.

Person responsible for the product

- The person responsible for the product has the following duties:
- To understand the safety instructions on the product and the instructions in the user manual.
 - To ensure that it is used in accordance with the instructions.
 - To be familiar with local regulations relating to safety and accident prevention.
 - To inform Leica Geosystems immediately if the product and the application becomes unsafe.
 - To ensure that the national laws, regulations and conditions for the operation of e.g. radio transmitters or lasers are respected.
-

1.5

Hazards of Use



CAUTION

Watch out for erroneous measurement results if the product has been dropped or has been misused, modified, stored for long periods or transported.

Precautions:

Periodically carry out test measurements and perform the field adjustments indicated in the user manual, particularly after the product has been subjected to abnormal use and before and after important measurements.



DANGER

Because of the risk of electrocution, it is dangerous to use poles and extensions in the vicinity of electrical installations such as power cables or electrical railways.

Precautions:

Keep at a safe distance from electrical installations. If it is essential to work in this environment, first contact the safety authorities responsible for the electrical installations and follow their instructions.



NOTICE

With the remote control of products, it is possible that extraneous targets will be picked out and measured.

Precautions:

When measuring in remote control mode, always check your results for plausibility.



WARNING

If the product is used with accessories, for example masts, staffs, poles, you may increase the risk of being struck by lightning.

Precautions:

Do not use the product in a thunderstorm.



WARNING

Inadequate securing of the working site can lead to dangerous situations, for example in traffic, on building sites, and at industrial installations.

Precautions:

Always ensure that the working site is adequately secured. Adhere to the regulations governing safety and accident prevention and road traffic.



CAUTION

If the accessories used with the product are not properly secured and the product is subjected to mechanical shock, for example blows or falling, the product may be damaged or people can sustain injury.

Precautions:

When setting-up the product, make sure that the accessories are correctly adapted, fitted, secured, and locked in position.

Avoid subjecting the product to mechanical stress.



CAUTION

During the transport, shipping or disposal of batteries it is possible for inappropriate mechanical influences to constitute a fire hazard.

Precautions:

Before shipping the product or disposing of it, discharge the batteries by running the product until they are flat.

When transporting or shipping batteries, the person in charge of the product must ensure that the applicable national and international rules and regulations are observed. Before transportation or shipping contact your local passenger or freight transport company.

**WARNING**

During dynamic applications, for example stakeout procedures there is a danger of accidents occurring if the user does not pay attention to the environmental conditions around, for example obstacles, excavations or traffic.

Precautions:

The person responsible for the product must make all users fully aware of the existing dangers.

**WARNING**

If you open the product, either of the following actions may cause you to receive an electric shock.

- Touching live components
- Using the product after incorrect attempts were made to carry out repairs

Precautions:

Do not open the product. Only Leica Geosystems authorised service workshops are entitled to repair these products.

**WARNING**

If the product is improperly disposed of, the following can happen:

- If polymer parts are burnt, poisonous gases are produced which may impair health.
- If batteries are damaged or are heated strongly, they can explode and cause poisoning, burning, corrosion or environmental contamination.
- By disposing of the product irresponsibly you may enable unauthorised persons to use it in contravention of the regulations, exposing themselves and third parties to the risk of severe injury and rendering the environment liable to contamination.

Precautions:

The product must not be disposed with household waste.

Dispose of the product appropriately in accordance with the national regulations in force in your country.

Always prevent access to the product by unauthorised personnel.

Product-specific treatment and waste management information can be downloaded from the Leica Geosystems home page at <http://www.leica-geosystems.com/treatment> or received from your Leica Geosystems dealer.

**WARNING**

Only Leica Geosystems authorised service workshops are entitled to repair these products.

**WARNING**

High mechanical stress, high ambient temperatures or immersion into fluids can cause leakage, fire or explosions of the batteries.

Precautions:

Protect the batteries from mechanical influences and high ambient temperatures. Do not drop or immerse batteries into fluids.

**WARNING**

If battery terminals are short circuited e.g. by coming in contact with jewellery, keys, metalized paper or other metals, the battery can overheat and cause injury or fire, for example by storing or transporting in pockets.

Precautions:

Make sure that the battery terminals do not come into contact with metallic objects.

1.6

Laser Classification

1.6.1

General

General

The following chapters provide instructions and training information about laser safety according to international standard IEC 60825-1 (2007-03) and technical report IEC TR 60825-14 (2004-02). The information enables the person responsible for the product and the person who actually uses the equipment, to anticipate and avoid operational hazards.



According to IEC TR 60825-14 (2004-02), products classified as laser class 1, class 2 and class 3R do not require:

- laser safety officer involvement,
- protective clothes and eyewear,
- special warning signs in the laser working area

if used and operated as defined in this User Manual due to the low eye hazard level.



National laws and local regulations could impose more stringent instructions for the safe use of lasers than IEC 60825-1 (2007-03) and IEC TR 60825-14 (2004-02).

1.6.2

Rugby 670/680

General

The rotating laser built into the product produces a visible laser beam which emerges from the rotating head.

The laser product described in this section is classified as laser class 2 in accordance with:

- IEC 60825-1 (2007-03): "Safety of laser products"
- EN 60825-1 (2007-10): "Safety of laser products"

These products are safe for momentary exposures but can be hazardous for deliberate staring into the beam. The beam may cause dazzle, flash-blindness and after-images, particularly under low ambient light conditions.

Rugby 670:

Description	Value
Maximum peak radiant power	2.7 mW ± 5%
Pulse duration (effective)	1.1 ms
Pulse repetition frequency	10 rps
Beam divergence	< 1.5 mrad
Wavelength	635 nm ± 10 nm

Rugby 680:

Description	Value
Maximum peak radiant power	2.7 mW ± 5%
Pulse duration (effective)	1.1 ms
Pulse repetition frequency	10 rps
Beam divergence	< 1.5 mrad
Wavelength	635 nm ± 10 nm

**CAUTION**

From a safety perspective, class 2 laser products are not inherently safe for the eyes.

Precautions:

- 1) Avoid staring into the beam.
- 2) Avoid pointing the beam at other people.

Labelling

005834.001
a) Laser beam

<p>Laser Radiation Do not stare into the beam Class 2 Laser Product according to IEC 60825-1 (2007 - 03)</p> <p>$P_o \leq 2.70 \text{ mW}$ $\lambda = 635 \pm 10 \text{ nm}$</p>
--

1.7**Electromagnetic Compatibility EMC****Description**

The term Electromagnetic Compatibility is taken to mean the capability of the product to function smoothly in an environment where electromagnetic radiation and electrostatic discharges are present, and without causing electromagnetic disturbances to other equipment.

**WARNING**

Electromagnetic radiation can cause disturbances in other equipment.

Although the product meets the strict regulations and standards which are in force in this respect, Leica Geosystems cannot completely exclude the possibility that other equipment may be disturbed.

**CAUTION**

There is a risk that disturbances may be caused in other equipment if the product is used with accessories from other manufacturers, for example field computers, personal computers or other electronic equipment, non-standard cables or external batteries.

Precautions:

Use only the equipment and accessories recommended by Leica Geosystems. When combined with the product, they meet the strict requirements stipulated by the guidelines and standards. When using computers or other electronic equipment, pay attention to the information about electromagnetic compatibility provided by the manufacturer.

**CAUTION**

Disturbances caused by electromagnetic radiation can result in erroneous measurements.

Although the product meets the strict regulations and standards which are in force in this respect, Leica Geosystems cannot completely exclude the possibility that the product may be disturbed by intense electromagnetic radiation, for example, near radio transmitters, two-way radios or diesel generators.

Precautions:

Check the plausibility of results obtained under these conditions.

**CAUTION**

If the product is operated with connecting cables attached at only one of their two ends, for example external supply cables, interface cables, the permitted level of electromagnetic radiation may be exceeded and the correct functioning of other products may be impaired.

Precautions:

While the product is in use, connecting cables, for example product to external battery, product to computer, must be connected at both ends.

Radios or digital cellular phones**WARNING**

Use of product with radio or digital cellular phone devices:

Electromagnetic fields can cause disturbances in other equipment, in installations, in medical devices, for example pacemakers or hearing aids and in aircraft. It can also affect humans and animals.

Precautions:

Although the product meets the strict regulations and standards which are in force in this respect, Leica Geosystems cannot completely exclude the possibility that other equipment can be disturbed or that humans or animals can be affected.

- Do not operate the product with radio or digital cellular phone devices in the vicinity of filling stations or chemical installations, or in other areas where an explosion hazard exists.
- Do not operate the product with radio or digital cellular phone devices near to medical equipment.
- Do not operate the product with radio or digital cellular phone devices in aircraft.

1.8**FCC Statement, Applicable in U.S.**

The greyed paragraph below is only applicable for products without radio.

**WARNING**

This equipment has been tested and found to comply with the limits for a Class B digital device, pursuant to part 15 of the FCC rules.

These limits are designed to provide reasonable protection against harmful interference in a residential installation.

This equipment generates, uses and can radiate radio frequency energy and, if not installed and used in accordance with the instructions, may cause harmful interference to radio communications. However, there is no guarantee that interference will not occur in a particular installation.

If this equipment does cause harmful interference to radio or television reception, which can be determined by turning the equipment off and on, the user is encouraged to try to correct the interference by one or more of the following measures:

- Reorient or relocate the receiving antenna.
- Increase the separation between the equipment and the receiver.
- Connect the equipment into an outlet on a circuit different from that to which the receiver is connected.
- Consult the dealer or an experienced radio/TV technician for help.

**WARNING**

Changes or modifications not expressly approved by Leica Geosystems for compliance could void the user's authority to operate the equipment.

Labelling Rugby 670/680



Labelling Rod Eye

Rod Eye 140:

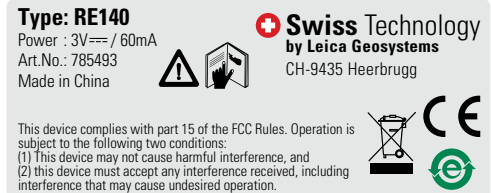

005146_001

Labelling Rod Eye

Rod Eye Basic:



005664_001

2 Description of the System

2.1 System Components

General description The Rugby 670 and Rugby 680 are semi-automatic lasers. Semi-automatic means that the laser self-levels only when in Level mode, not when grade is entered.

The Rugby 670 and Rugby 680 are laser tools for general construction and levelling applications such as:

- Setting forms
- Checking grades
- Controlling depths for excavations

If set up within the self-levelling range, the Rugby automatically levels to create an accurate horizontal plane of laser light.

Once the Rugby has levelled, the head will start rotating and the Rugby is ready for use.

30 seconds after the Rugby has completed the levelling, the Elevation Alert (H.I.) function becomes active and protects the Rugby against changes in elevation caused by movement of the tripod to ensure accurate work.

The Rugby 670 and Rugby 680 can also be used to create sloped planes for applications such as:

- Driveways
- Parking lots
- Landscaping

In Grade mode the Rugby checks first the position of the beam at level, then adjusts to the desired grade input. If a single grade is entered, the cross axis will continue to self-level.

Once the Rugby has reached the desired grade, it does not self-level, but is monitored by Bump Alert and temperature change functions to ensure reliable grade values.

Available system components



The delivered components depend on the package ordered.

2.2

Rugby Laser Components

Rugby laser components

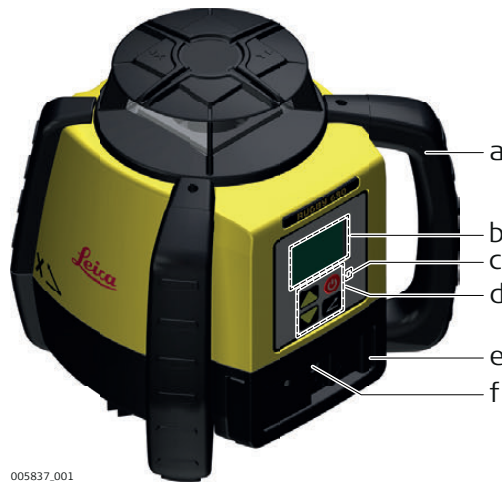

- a) Carry handle
- b) LCD display
- c) Laser emission LED
- d) Buttons
- e) Battery compartment
- f) Charge jack (for Li-Ion battery pack)

005837_001

2.3

Case Components

Case components

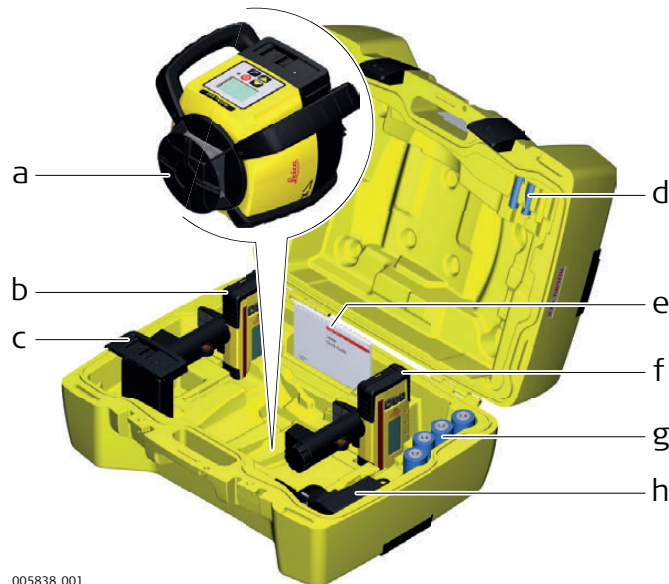

005838_001

- a) Rugby laser
- b) Rod eye receiver mounted on the bracket
- c) Li-Ion battery pack or Alkaline battery pack
- d) 2x AA-cell battery
- e) User Manual/CD
- f) Second receiver (can be purchased separately)
- g) 4 x D-cell battery (for alkaline versions only)
- h) Charger (for Li-Ion versions only)

Location

- Keep the location clear of possible obstructions that could block or reflect the laser beam.
- Place the Rugby on a stable ground. Ground vibration and extremely windy conditions can affect the operation of the Rugby.
- When working in a very dusty environment place the Rugby up-wind so the dirt is blown away from the laser.

Setting up on a Tripod - Level

005839_001

Step	Description
1.	Set up the tripod.
2.	Place the Rugby on the tripod.
3.	Tighten the screw on the underside of the tripod to secure the Rugby on the tripod.

- Attach the Rugby securely to a tripod or laser trailer, or mount on a stable level surface.
- Always check the tripod or laser trailer before attaching the Rugby. Make sure all screws, bolts and nuts are tight.
- If a tripod has chains, they should be slightly loose to allow for thermal expansion during the day.
- Secure the tripod on extremely windy days.

Setting up on a Tripod - Grade



005839_001



005943_001

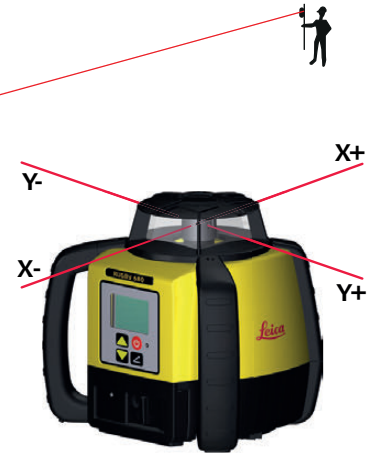

Step	Description
1.	Set up the tripod.
2.	Place the Rugby on the tripod.
3.	Align the axes of the laser to the job.
4.	Tighten the screw on the underside of the tripod to secure the Rugby on the tripod.

- Attach the Rugby securely to a tripod or laser trailer, or mount on a stable level surface.
- Always check the tripod or laser trailer before attaching the Rugby. Make sure all screws, bolts and nuts are tight.
- If a tripod has chains, they should be slightly loose to allow for thermal expansion during the day.
- Secure the tripod on extremely windy days.

3

Operation

3.1

User Interface

Overview

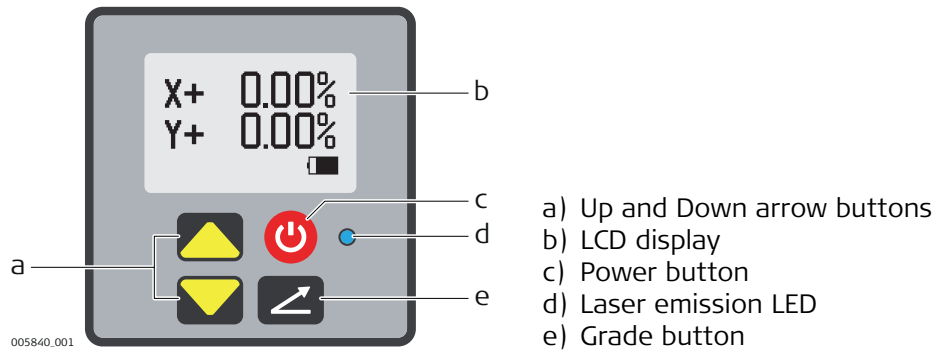

Description

Item	Function
Up and Down arrow buttons	Press the Up and Down buttons to enter a grade or highlight options in the Option Menu.
LCD display	Displays user information.
Power button	Press to turn the Rugby on or off.
Laser emission LED	The LED flashes when the laser beam is flashing. The LED is on when the laser beam is on.
Grade buttons	Press to start grade entry process or accept settings in the Option Menu.

3.2

LCD Display Information

Start up screens



When the Rugby is turned on, the Leica Start up screen is shown followed by the Rugby Information screen displaying the following information:

- Model and type
- Serial number
- Software revision level
- Hours of use

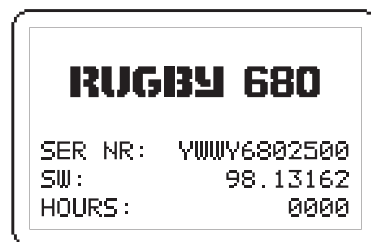

Main user screen

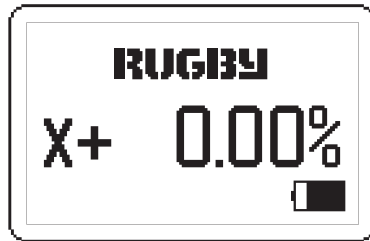

006040.001

Rugby 670

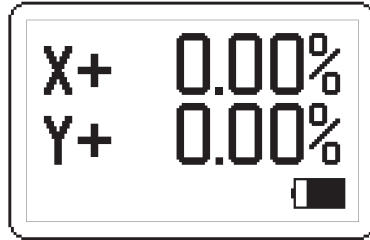

006039.001

Rugby 680

The Main user screens show the grade input.



The screens are different for the Rugby 670 (single grade) and Rugby 680 (dual grade).

Level mode screen

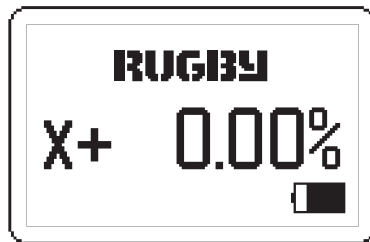

006040.001

Rugby 670

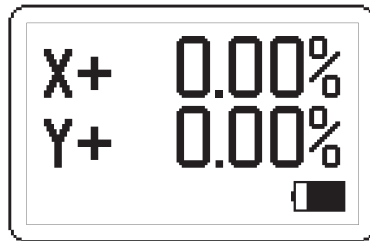

006039.001

Rugby 680

The grade shown must be 0.00% to use the Rugby 670/680 in Level mode, for example for forms and footings. In Level mode, the Rugby 670/680 automatically levels to the horizontal plane.

Grade mode screen

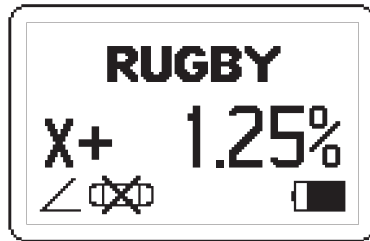

006057.001
Rugby 670

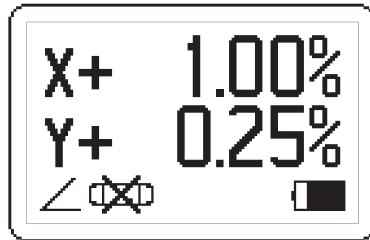

006056.001
Rugby 680

Enter your desired grade in Grade mode. The Rugby 670/680 will check the level position and then adjust the plane of laser light to the grade input.

In Grade mode, the Rugby 670/680 does not self-level, but is set to detect bumps and temperature changes.

A small icon in the bottom left corner of the screen indicates that the axis with grade is not self-levelling.

3.3

Grade Entry

Entering grade

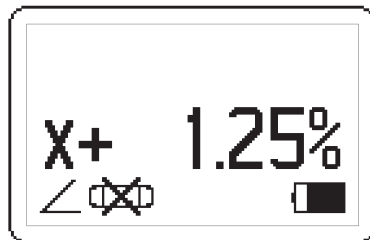

006043.001
Rugby 670: X-axis entry



006041.001
Rugby 680: X-axis entry

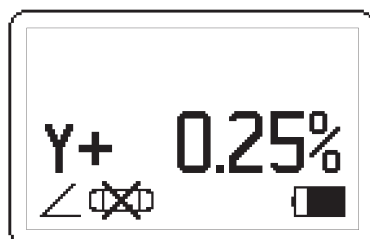





006042.001
Rugby 680: Y-axis entry

The Rugby 670/680 always starts up with no grade input.

To enter grade, do the following:

- 1) Press the Grade button once to enter Grade mode.
- 2) Press the Up and Down arrow buttons to enter a grade for the X-axis.
- 3) Rugby 680 only: Press the Grade button a second time to switch to the Y-axis.
- 4) Rugby 680 only: Press the Up and Down arrow buttons to enter a grade for the Y-axis.
- 5) Press the Grade button again to return to the Main user screen.

The Rugby will begin the grade setting process.

-  The smallest grade increment is 0.05% up to 3.00% grade and 0.10% for grade greater than 3.00%.
-  When entering grade the displays change as shown.
-  To restore the last set grade(s), press and hold the Grade button for 1.5 seconds.
-  If after eight seconds no button is pressed, the Rugby will accept the grade entered and will begin the grade setting process.

Grade setting process

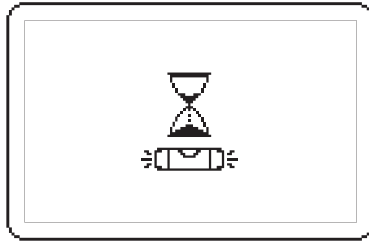

Levelling to grade screen

After grade entry for one or both axes, the Rugby waits for 8 seconds of no movement or button presses before beginning the process. The Rugby then displays the Levelling to grade screen and automatically self-levels in the horizontal plane, followed by readjusting the servo mechanism to the desired grade value.

After completion, the Rugby activates the Slope/Bump Alert and Temperature Alert functions (if enabled).

 During this process, do not touch or disturb the Rugby.

3.4

Elevation (H.I.) Alert, Bump Alert and Smart Slope Functions

Elevation (H.I.) Alert



Elevation (H.I.) Alert screen

The Elevation Alert or Height of Instrument (H.I.) function prevents incorrect work caused by movement or settling of the tripod that would cause the Rugby to level at a lower height.

The Elevation (H.I.) Alert function becomes active and monitors the movement of the Rugby 30 seconds after it has completely levelled and the head starts rotating.

If the Rugby gets disturbed, the Elevation (H.I.) Alert screen is displayed and the Rugby beeps rapidly.

To stop the alert, turn the Rugby off and on again. Check the height of the laser before beginning to work again.

 The Elevation (H.I.) Alert functions in Level mode (0.00%) and in Grade mode when one of the axes remains at 0.00%.

 The Elevation (H.I.) Alert function turns on automatically every time the Rugby is turned on. It can be enabled/disabled in the Option Menu (enabled by default).

Bump Alert

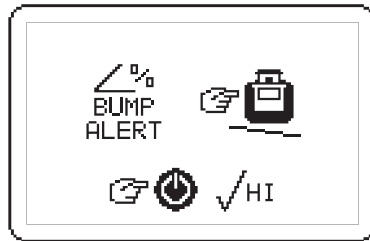

006046.001
Bump Alert screen

The Bump Alert function prevents incorrect work caused by movement or settling of the tripod that occurs when the Rugby is used for grade.

The Bump Alert function becomes active and monitors the movement of the Rugby when it has completely levelled and the head starts rotating.

If the Rugby gets disturbed, the Bump Alert screen is displayed and the Rugby beeps rapidly.

To stop the alert, do one of the following:

- If the height has not changed, press the Grade button for 1.5 seconds to stop the alert and continue working. The Rugby will check level and return to desired grade.
- If the height has changed, turn the Rugby off and on again, check the height of the laser and reenter the grade.

 If one axis is still set to Level mode (0.00%), the Elevation (H.I.) Alert function is also active for this axis.

 The Bump Alert function turns on automatically every time grade is entered in the Rugby. It can be enabled/disabled in the Option Menu (enabled by default).

 The Bump Alert function can be set to FINE or COARSE in the Option Menu (COARSE by default).

Smart Slope

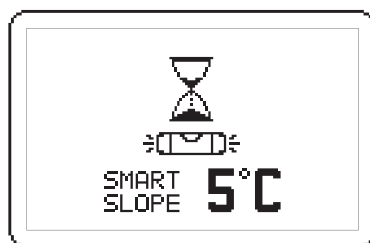

006048.001
Smart Slope screen: COARSE

If the Rugby detects a change in ambient temperature, the grade mechanism will return to level position, check level and return to the grade set.

During this, the Rugby cannot be used and the Smart Slope screen is displayed.

There are two settings for the Smart Slope function:

- FINE: 2°C temperature change
- COARSE: 5°C temperature change

 The Smart Slope setting can be changed in the Option Menu (COARSE by default).

Option Menu

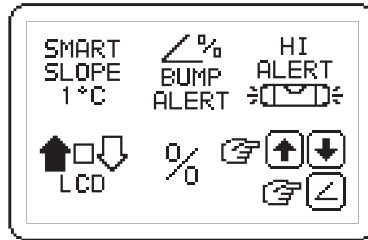

006050.001

Option Menu

Press both the Up arrow button and Power button for 1.5 seconds to enter the Option Menu.

There are five options available:

- Smart Slope: FINE/COARSE/OFF
- Bump Alert: FINE/COARSE/OFF
- H.I. Alert: ON/OFF at start up
- Contrast
- Percent/Per mil

Selecting an option

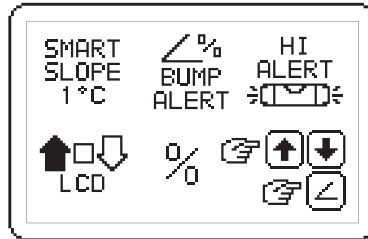

006050.001

Option Menu

- 1) Press the Up arrow or Down arrow button to highlight the option to change.
- 2) Press the Grade button to enter the selected option screen.

Changing an option

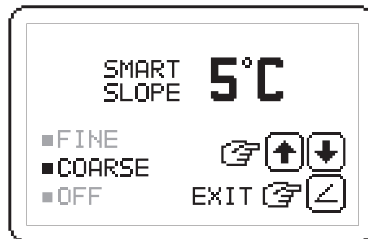

006146.001

Smart Slope option

- 1) Press the Up arrow or Down arrow button to highlight the desired option.
- 2) Press the Grade button to confirm the setting and return to the Option Menu.

Percent/Per mil

 Do not change this option unless you are sure you want to work with Per mil values (Percent by default).



006053.001

Percent/Per mil option

Changing from Percent to Per mil moves the decimal point one place to the right:

- Percent: 1 m per 100 m
- Per mil: 1 m per 1,000 m (1 mm per 1 m)



006145.001
Confirm Percent

☞ If changing from Percent to Per mil, confirmation for the change is necessary.

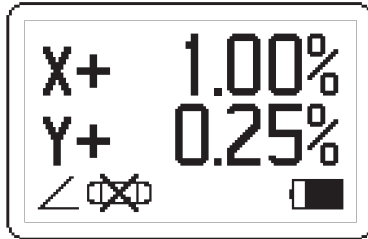

006054.001
Percent

☞ The Percent and Per mil screens to the left are equal.

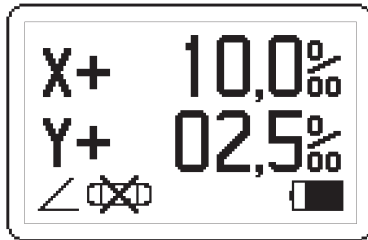

006055.001
Per mil

Description

The Rugby 670 and Rugby 680 are sold with the Rod Eye 140 Classic or Rod Eye Basic Receiver.

4.1**Rod Eye 140, Classic Receiver****Instrument components part 1 of 2**

005147.001

- a) Level vial
- b) Audio Speaker
- c) LCD window
- d) LEDs
- e) Laser Reception window
- f) On-grade
- g) Keypad

Component	Description
Level vial	Aids to keep the rod plumb when taking readings.
Audio Speaker	Indicates the detector's position: <ul style="list-style-type: none"> • High - Fast beeping • On-grade - Solid tone • Low - Slow beeping
LCD window	Front and rear LCD arrow indicate the detector's position.
LEDs	Display the relative position of the laser beam. Three channel indication: <ul style="list-style-type: none"> • High - Red • On-grade - Green • Low - Blue
Laser Reception window	Detects the laser beam. The reception windows must be directed towards the laser.
On-grade	Indicates the on-grade position of the laser.
Keypad	Power, accuracy and volume functions. Refer to "Description of the Buttons" for detailed information.

Instrument components part 2 of 2

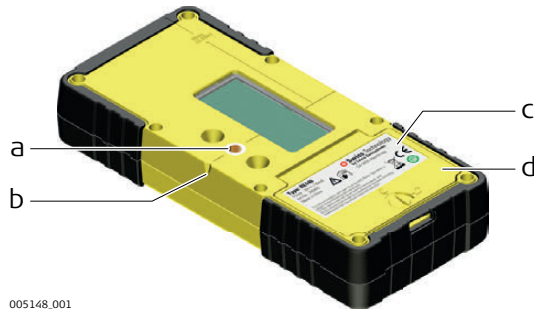

005148.001

- a) Bracket Mounting Hole
- b) Offset notch
- c) Product label
- d) Battery door

Component	Description
Bracket Mounting Hole	Location to attach the receiver bracket for normal operation.
Offset notch	Use to transfer reference marks. The notch is 85 mm (3.35") below to top of the detector.
Product label	The serial number is located inside the battery compartment.
Battery door	Access to the battery compartment.

Description of the Buttons



005149.001

- a) Power
- b) Audio
- c) Bandwidth

Button	Function
Power	Press once to turn on the Receiver.
Audio	Press to change the audio output.
Bandwidth	Press to change detection bandwidth.

4.2

Menu - Rod Eye 140, Classic Receiver

Menu access and navigation

To access the menu of the Rod Eye 140 Classic Receiver, press the Bandwidth button and Audio button simultaneously.

- Use the Bandwidth button and Audio button to change parameters.
- Use the Power button to scroll through the menu.

Menu

 MENU MODE - The blue LED will blink slowly indicating menu mode.

Menu	Function	Indication
LED Red and Green LEDs change brightness to indicate this parameter.	Changes the brightness of the LED indicators.	Red and green LEDs - High/Low/Off
BAT The laser icon flashes to indicate this parameter.	Turns on or off the Laser low battery indication on the receiver.	Green LED is on: Laser low battery icon function is active. Red LED is on: Laser low battery icon function is not active.
MEM The down arrow bars are filling to indicate this parameter.	Turns on or off the position memory function.	Green LED is on: function is on. Red LED is on: function is off.

4.3

Rod Eye Basic Receiver

Instrument components part 1 of 2

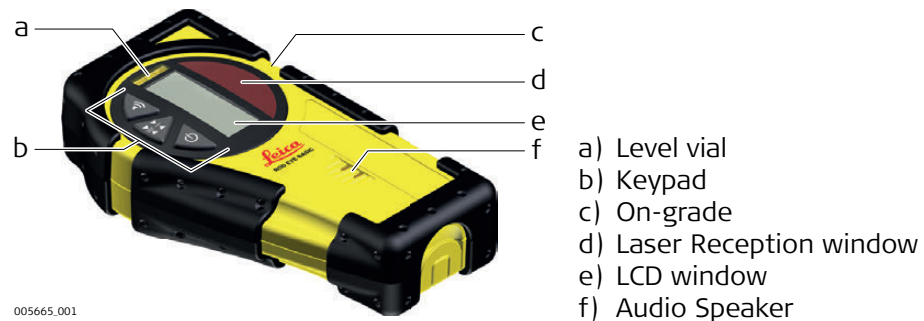

Component	Description
Level vial	Aids to keep the rod plumb when taking readings.
Keypad	Power, accuracy and volume functions. Refer to "Description of the buttons" for detailed information.
On-grade	Indicates the on-grade position of the laser.
Laser Reception window	Detects the laser beam. The reception windows must be directed towards the laser.
LCD window	Front and rear LCD arrow indicate the detector's position.
Audio Speaker	Indicates the detector's position: <ul style="list-style-type: none"> • High - Fast beeping • On-grade - Solid tone • Low - Slow beeping

**Instrument components
part 2 of 2**

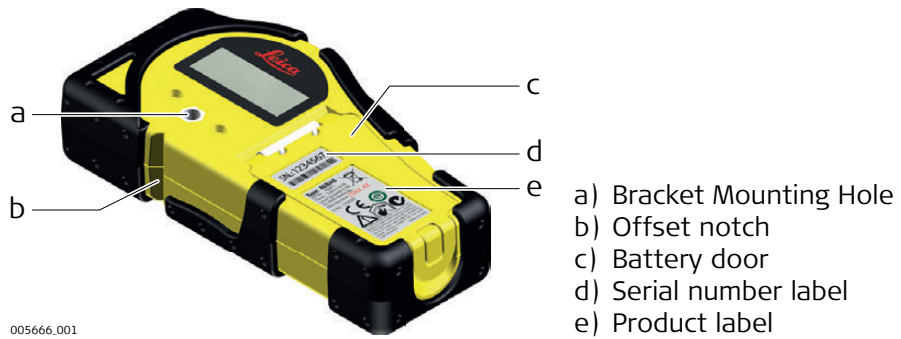

Component	Description
Bracket Mounting Hole	Location to attach the receiver bracket for normal operation.
Offset notch	Use to transfer reference marks. The notch is 45 mm (1.75") below to top of the detector.
Battery door	Access to the battery compartment.

**Description of the
buttons**



Button	Function
Audio	Press to change the audio output.
Bandwidth	Press to change detection bandwidth.
Power	Press once to turn on the Receiver.

5 Applications

5.1 Setting Forms

Setting Forms step-by-step

Application shown using the Rod Eye 140, Classic Receiver.

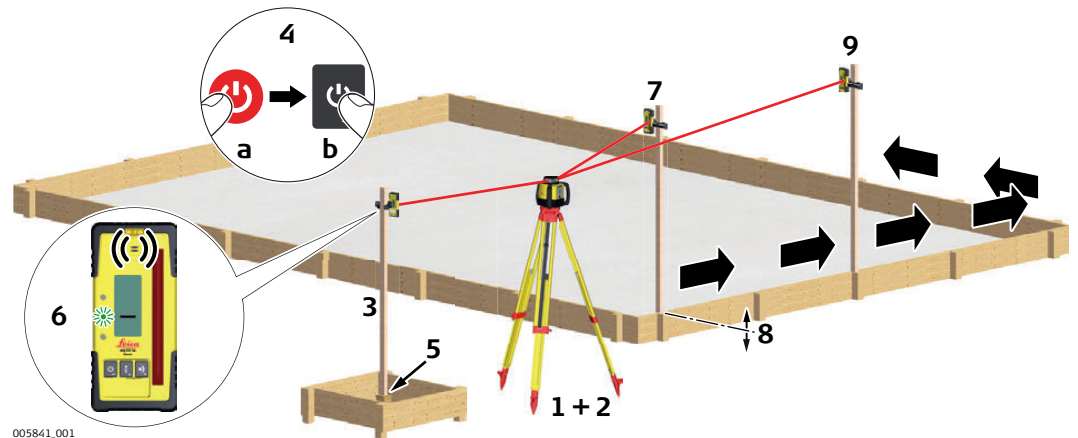

005841.001

Step	Description
1.	Set up the Rugby on a tripod.
2.	Set up the tripod on a stable surface outside the working area.
3.	Attach the receiver to a rod.
4.	Turn on the Rugby and the receiver.
5.	Set the base of the rod on a known point for the finished height of forms.
6.	Adjust the height of the receiver on the rod until the on-grade (centre-line) position is indicated on the receiver by: <ul style="list-style-type: none"> the centre bar the green flashing LED a solid audio tone
7.	Set the rod with the attached receiver on top of the form.
8.	Adjust the height of the form until the on-grade position is again indicated.
9.	Continue to additional positions until the forms are levelled to the rotating plane of the Rugby.

5.2

Checking Grades

Checking Grades step-by-step

Application shown using the Rod Eye 140, Classic Receiver.

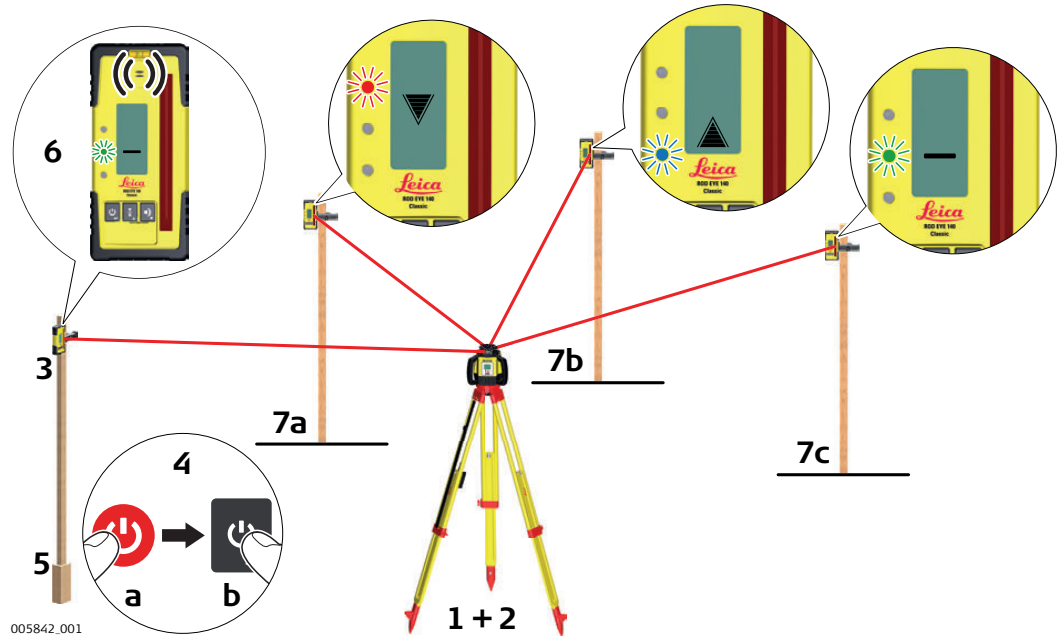

005842_001

Step	Description
1.	Set up the Rugby on a tripod.
2.	Set up the tripod on a stable surface outside the working area.
3.	Attach the receiver to a rod.
4.	Turn on the Rugby and the receiver.
5.	Set the base of the rod on a known point for the finished grade.
6.	Adjust the height of the receiver on the rod until the on-grade (centre-line) position is indicated on the receiver by: <ul style="list-style-type: none"> • the centre bar • the green flashing LED • a solid audio tone
7.	Set the rod with the attached receiver on top of the excavation or concrete pour to check for correct elevation.
8.	Variances can be read in precise measurements with the digital receiver. <ul style="list-style-type: none"> • 7a: Position is too high. • 7b: Position is too low. • 7c: Position is on grade.

5.3

Entering Grades

Entering Grades step-by-step

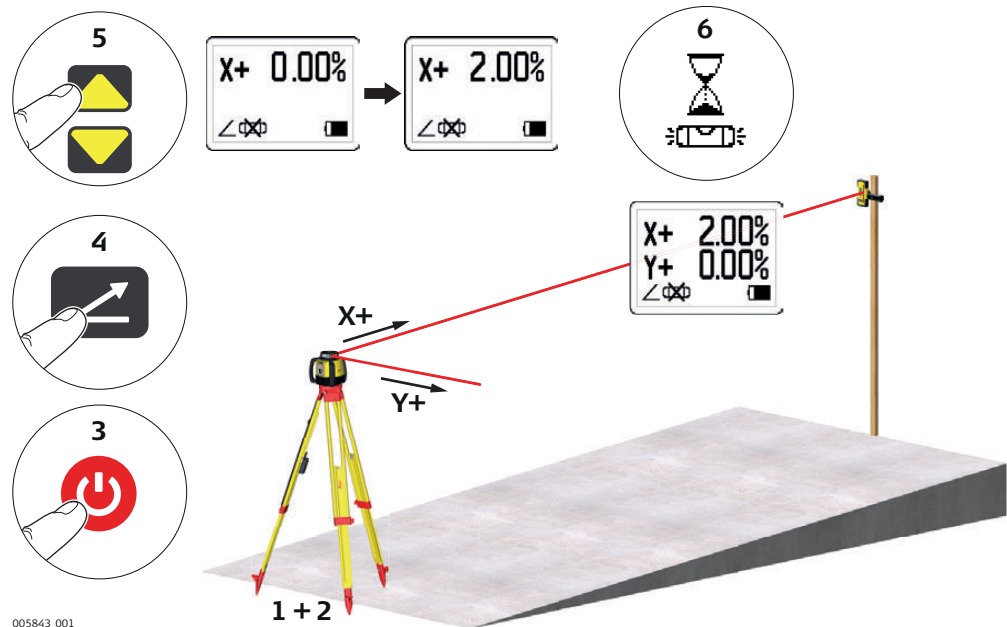

Step	Description
1.	Set up the Rugby on a tripod.
2.	Set up the tripod at the base of the slope with the x-axis pointing in the direction of the slope.
3.	Turn on the Rugby.
4.	Press the Grade button.
5.	Press the Up or Down button to enter grade for the x-axis (single slope). <ul style="list-style-type: none"> • For Rugby 670: press the Grade button again to exit grade entry mode. • For Rugby 680: press the Grade button to enter grade for the y-axis. Press the Grade button again to exit grade entry mode.
6.	Once grade is entered, the Rugby will begin to adjust to grade. Do not disturb the Rugby during this process.

 To restore previous grade, press and hold the Grade button for 1.5 seconds.

6 Batteries

Description The Rugby 670 and Rugby 680 can be purchased with alkaline batteries or a rechargeable Li-Ion battery pack.
The following information is appropriate only to the model you have purchased.

6.1 Operating Principles

Charging / first-time use

- The battery must be charged prior to using it for the first time because it is delivered with an energy content as low as possible.
- The permissible temperature range for charging is between 0°C to +40°C/ +32°F to +104°F. For optimal charging, we recommend charging the batteries at a low ambient temperature of +10°C to +20°C/+50°F to +68°F if possible.
- It is normal for the battery to become warm during charging. Using the chargers recommended by Leica Geosystems, it is not possible to charge the battery if the temperature is too high.
- For new batteries or batteries that have been stored for a long time (> three months), it is effectual to make only one charge/discharge cycle.
- For Li-Ion batteries, a single discharging and charging cycle is sufficient. We recommend carrying out the process when the battery capacity indicated on the charger or on a Leica Geosystems product deviates significantly from the actual battery capacity available.

Operation / Discharging

- The batteries can be operated from -20°C to +55°C/-4°F to +131°F.
- Low operating temperatures reduce the capacity that can be drawn; high operating temperatures reduce the service life of the battery.

6.2 Battery for Rugby

Charging the Li-Ion battery pack step-by-step

The rechargeable Li-Ion battery pack on the Rugby can be charged without removing the battery pack from the laser.



Step	Description
1.	Slide the locking mechanism on the battery compartment to the very left to expose the charge jack.
2.	Plug the AC connector into the appropriate AC power source.
3.	Connect the charger plug into the charge jack on the Rugby battery pack.

Step	Description
4.	The small LED next to the charge jack flashes indicating that the Rugby is charging. The LED is on solid when the battery pack is fully charged.
5.	When the battery pack is fully charged, disconnect the charger plug from the charge jack.
6.	Slide the locking mechanism to the centre position to prevent dirt from getting into the charging jack.



 The battery pack reaches a full charge in approximately 5 hours if completely empty. A one hour charge should allow the Rugby to run for a full eight hours.

Changing the Li-Ion batteries step-by-step

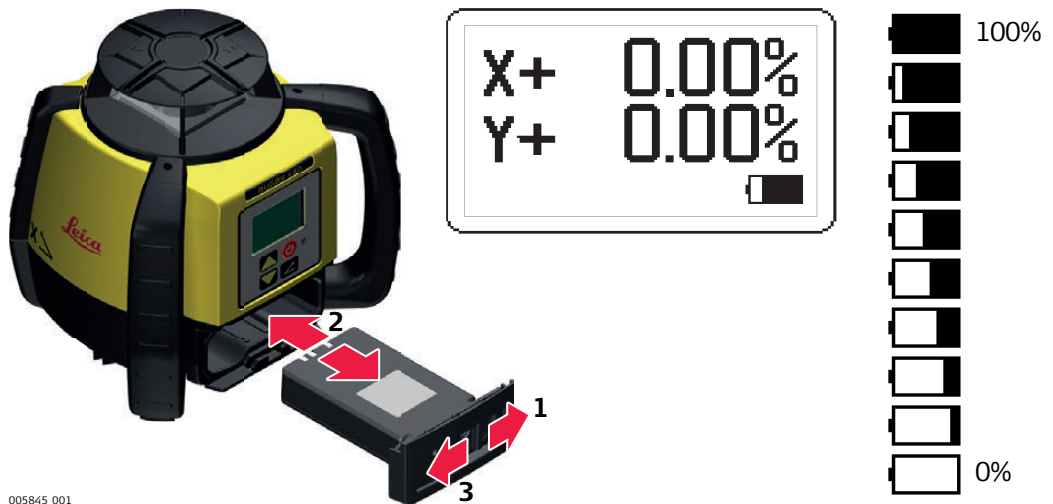
With the rechargeable Li-Ion battery pack the battery indicator on the Rugby LCD display shows when the battery pack is low and needs to be charged. The charge indicator LED on the Li-Ion battery pack indicates when the pack is being charged (flashing slowly) or fully charged (on, not flashing).



005845.001



Step	Description
	The batteries are inserted in the front of the laser.
	The rechargeable battery pack can be recharged without being removed from the laser. Refer to "Charging the Li-Ion battery pack step-by-step" for further information.
1.	Slide the locking mechanism on the battery compartment to the right and open the cover of the battery compartment.
2.	To remove the batteries: Remove the batteries from the battery compartment.
	To insert the batteries: Insert the batteries into the battery compartment.
3.	Close the cover of the battery compartment and slide the locking mechanism to the left centre position until it locks into position.

Changing the alkaline batteries step-by-step

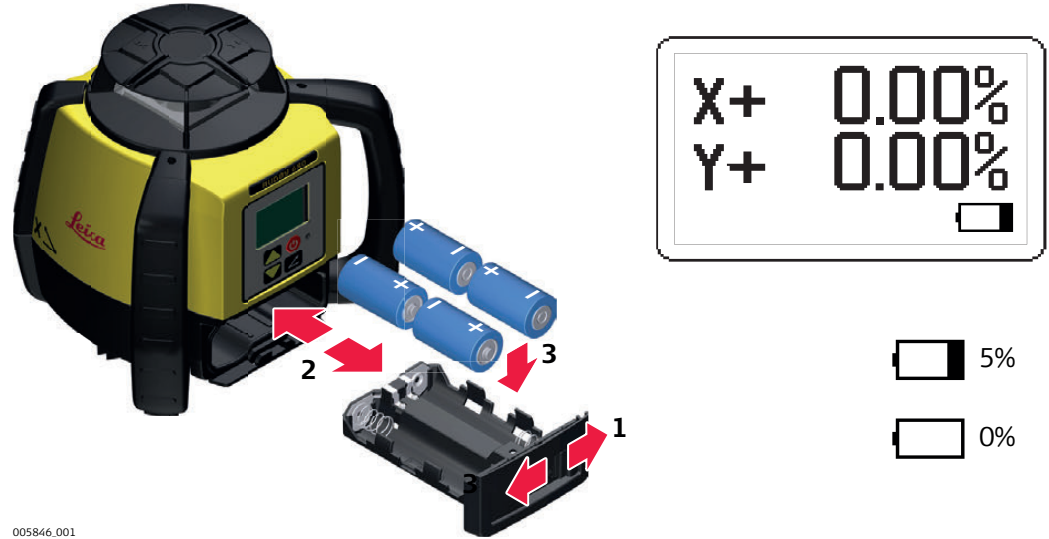
With alkaline batteries the battery indicator on the Rugby LCD display flashes when the batteries are low and need to be replaced. If no battery icon is shown, the batteries are okay.



005846.001

Step	Description
	The batteries are inserted in the front of the laser.
1.	Slide the locking mechanism on the battery compartment to the right and open the cover of the battery compartment.
2.	To remove the batteries: Remove the batteries from the battery compartment.
	To insert the batteries: Insert the batteries into the battery compartment, ensuring that the contacts are facing in the right direction.  The correct polarity is displayed on the battery holder.
3.	Close the cover of the battery compartment and slide the locking mechanism to the left until it locks into position.

About

- It is the responsibility of the user to follow operating instructions and to periodically check the accuracy of the laser and work as it progresses.
- The Rugby is adjusted to the defined accuracy specification at the factory. It is recommended to check the laser for accuracy upon receipt and periodically thereafter to ensure accuracy is maintained. If the laser requires adjustment, contact your nearest authorised service centre or adjust the laser using the procedures described in this chapter.
- Only enter the accuracy adjustment mode when you plan to change the accuracy. Accuracy adjustments should only be performed by a qualified individual that understands basic adjustment principles.
- It is recommended to perform this procedure with two people on a relatively flat surface.

7.1

Checking the Level Accuracy

Checking the level accuracy step-by-step

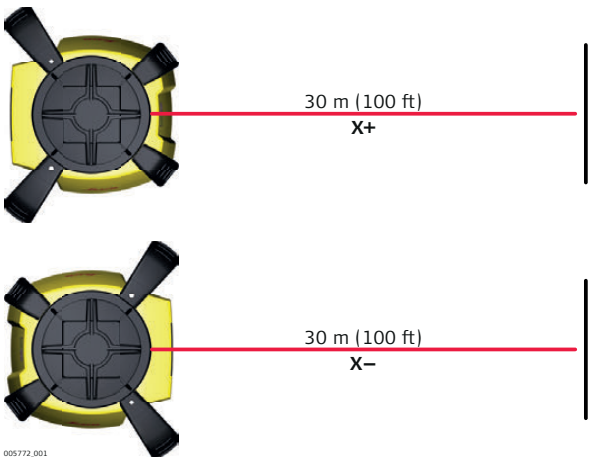
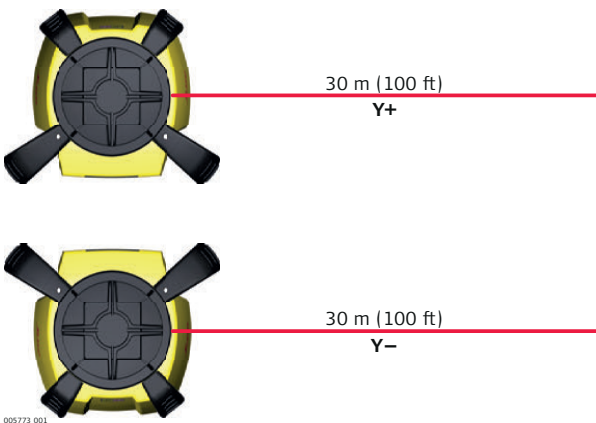
Step	Description
1.	Place the Rugby on a flat, level surface or tripod approximately 30 m (100 ft) from a wall.
	 <p>005772.001</p>
2.	Align the first axis so that it is square to a wall. Allow the Rugby to self-level completely (approximately 1 minute after the Rugby begins to rotate).
3.	Mark the position of the beam.
4.	Rotate the laser 180° and allow it to self-level.
5.	Mark the opposite side of the first axis.
	 <p>005773.001</p>

Step	Description
6.	Align the second axis of the Rugby by rotating it 90° so that this axis is square to the wall. Allow the Rugby to self-level completely.
7.	Mark the position of the beam.
8.	Rotate the laser 180° and allow it to self-level.
9.	Mark the opposite side of the second axis.

 The Rugby is within its accuracy specification if the four marks are within ± 1.5 mm ($\pm 1/16$ ") from the centre.

7.2 Adjusting the Level Accuracy

Description

In Calibration mode the X-axis calibration screen indicates changes to the X-axis.

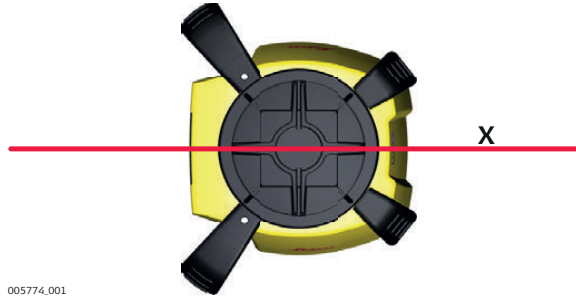

The Y-axis calibration screen indicates changes to the Y-axis.

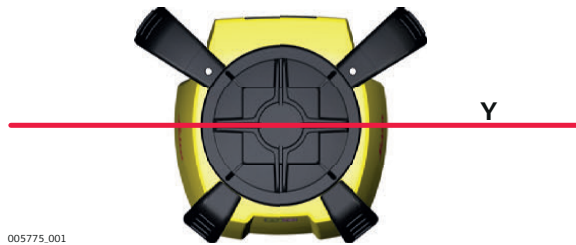

Entering Calibration mode step-by-step

Step	Description
1.	Turn off the power.
2.	Put the Rugby in an upright position.
3.	Press and hold both the Up and Down Arrow buttons.
4.	Press the Power button. The X-axis calibration screen appears. The Rugby is now in Calibration mode.

 In Calibration mode, the LED does not blink and the laser head continues to rotate. An hour-glass indicates that the Rugby is levelling.

Calibrating the X-axis step-by-step

Upon entering Calibration mode, the X-axis calibration screen appears:

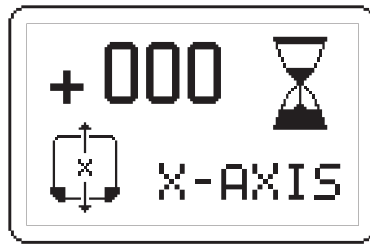

006059.001

Step	Description
1.	When the hour glass has disappeared, indicating that the Rugby has levelled, check both sides of the X-axis.
2.	Press the Up and Down arrow buttons to bring the plane of laser light to the specified level position.  Each step represents approximately 2 arc seconds of change. Therefore, 5 steps equal approximately 1.5 mm at 30 m (1/16" at 100').
3.	Press the Grade button to accept the adjusted position and to switch to the Y-axis calibration screen.

Calibrating the Y-axis step-by-step

After calibration of the X-axis, the Y-axis calibration screen appears:

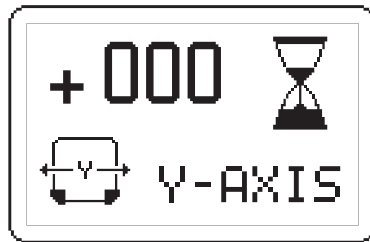

006060.001

Step	Description
1.	When the hour glass has disappeared, indicating that the Rugby has levelled, check both sides of the Y-axis.
2.	Press the Up and Down arrow buttons to bring the plane of laser light to the specified level position.  Each step represents approximately 2 arc seconds of change. Therefore, 5 steps equal approximately 1.5 mm at 30 m (1/16" at 100').
3.	Press the Grade button to accept the adjusted position and to switch to the X-axis calibration screen.
4.	Press and hold the Grade button for 3 seconds to accept the adjusted positions, save and store the calibration settings and return to the Main User screen.







Exiting Calibration mode

Press and hold the Grade button for 3 seconds to save and exit Calibration mode.

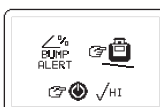

Pressing the Power button at any time while in Calibration mode will exit the mode without saving changes.

Alerts

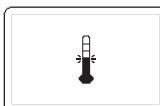
Alert	Symptom	Possible causes and solutions
	Low Battery indication on the display.	The batteries are low. Replace the alkaline batteries or recharge the Li-Ion battery pack. Refer to "6 Batteries".
	Elevation (H.I.) Alert The Elevation (H.I.) Alert screen is shown and the audio beeps. (Level position)	The Rugby has been bumped or tripod was moved. Turn off Rugby to stop alert, check the height of the laser before beginning to work again. Allow Rugby to re-level and check the height of the laser. After two minutes in the alert condition, the unit will shut off automatically.
	Bump Alert The Bump Alert screen is shown and the audio beeps. (Grade position)	The Rugby has been bumped or tripod was moved. Turn off Rugby to stop alert, check the height of the laser before beginning to work again. Allow Rugby to re-level and check the height of the laser. After two minutes in the alert condition, the unit will shut off automatically.
	Servo Limit Alert The Servo Limit Alert screen is shown.	The Rugby is tipped too far to reach a level position. Re-level the Rugby within the 6 degree self-levelling range. After two minutes in the alert condition, the unit will shut off automatically.
	Tilt Alert The Tilt Alert screen is shown.	The Rugby is tipped more than 45° from level. After two minutes in the alert condition, the unit will shut off automatically.
	Smart Slope Alert The Smart Slope Alert screen is shown.	The Rugby is checking the level position before returning to grade. Refer to "Smart Slope".
	Temperature Alert The Temperature Alert screen is shown.	The Rugby is in an environment where it cannot operate without causing damage to the laser diode. This could be a result of heat from direct sunlight. Shade the Rugby from the sun. After two minutes in the alert condition, the unit will shut off automatically.

Troubleshooting

Problem	Possible Cause(s)	Suggested Solutions
The Rugby is working, but not self-levelling.	The Rugby is in Grade Mode.	The Rugby will self-level only when 0.00% is shown in the display. In Grade mode, the Rugby self-levels at 0.00%, then adjusts to the grade input.
Rugby does not turn on.	The batteries are low or dead.	Check the batteries and change or charge the batteries if necessary. If the problem continues, return the Rugby to an authorised service centre for service.
The distance of the laser is reduced.	Dirt is reducing the laser output.	Clean the windows of the Rugby and the receiver. If the problem continues, return the Rugby to an authorised service centre for service.
The laser receiver is not working properly.	The head is not rotating. The Rugby may be levelling or in Elevation (H.I.) Alert.	Check for proper operation of the Rugby.  Refer to the receiver manual for more information.
	The receiver is out of usable range.	Move closer to the Rugby.
	The batteries of the receiver are low.	Change the receiver batteries.
Elevation (H.I.) Alert function is not working.	The Elevation (H.I.) Alert function is disabled.	The Elevation (H.I.) Alert function can be enabled or disabled in the Option Menu.
The Bump Alert feature activates too often.	The Bump Alert setting is too sensitive.	Change the Bump Alert setting from FINE to COARSE in the Option Menu.
The Smart Slope feature activates too often.	The Smart Slope setting is too sensitive.	Change the Smart Slope setting from FINE to COARSE in the Option Menu.
The display is too dark/light.	Contrast setting needs readjustment to lighting conditions.	Adjust the contrast setting in the Option Menu.
The grade shows in Percent (%) or Per mil (‰).	Wrong setting chosen.	Choose the desired setting in the Option Menu.

9 Care and Transport

9.1 Transport

Transport in the field	When transporting the equipment in the field, always make sure that you <ul style="list-style-type: none">• either carry the product in its original transport container,• or carry the tripod with its legs splayed across your shoulder, keeping the attached product upright.
Transport in a road vehicle	Never carry the product loose in a road vehicle, as it can be affected by shock and vibration. Always carry the product in its transport container and secure it.
Shipping	When transporting the product by rail, air or sea, always use the complete original Leica Geosystems packaging, transport container and cardboard box, or its equivalent, to protect against shock and vibration.
Shipping, transport of batteries	When transporting or shipping batteries, the person in charge of the product must ensure that the applicable national and international rules and regulations are observed. Before transportation or shipping, contact your local passenger or freight transport company.
Field adjustment	Periodically carry out test measurements and perform the field adjustments indicated in the User Manual, particularly after the product has been dropped, stored for long periods or transported.

9.2 Storage

Product	Respect the temperature limits when storing the equipment, particularly in summer if the equipment is inside a vehicle. Refer to "Technical Data" for information about temperature limits.
Field adjustment	After long periods of storage inspect the field adjustment parameters given in this user manual before using the product.
Li-Ion and alkaline batteries	For Li-Ion and alkaline batteries <ul style="list-style-type: none">• Refer to "Technical Data" for information about storage temperature range.• Remove batteries from the product and the charger before storing.• After storage recharge batteries before using.• Protect batteries from damp and wetness. Wet or damp batteries must be dried before storing or use. For Li-Ion batteries <ul style="list-style-type: none">• A storage temperature range of -20°C to +30°C/-4°F to 86°F in a dry environment is recommended to minimise self-discharging of the battery.• At the recommended storage temperature range, batteries containing a 50% to 100% charge can be stored for up to one year. After this storage period the batteries must be recharged.

Product and accessories

- Blow dust off lenses and prisms.
- Never touch the glass with your fingers.
- Use only a clean, soft, lint-free cloth for cleaning. If necessary, moisten the cloth with water or pure alcohol. Do not use other liquids; these can attack the polymer components.

Damp products

Dry the product, the transport container, the foam inserts and the accessories at a temperature not greater than 40°C / 104°F and clean them. Remove the battery cover and dry the battery compartment. Do not repack until everything is completely dry. Always close the transport container when using in the field.

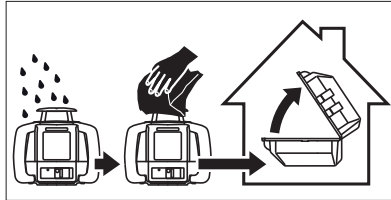
**Cables and plugs**

Keep plugs clean and dry. Blow away any dirt lodged in the plugs of the connecting cables.

10

Technical Data

10.1

Conformity to National Regulations

Conformity to national regulations

For products which do not fall under R&TTE directive:



Hereby, Leica Geosystems AG, declares that the product/s is/are in compliance with the essential requirements and other relevant provisions of the applicable European Directives. The declaration of conformity can be consulted at <http://www.leica-geosystems.com/ce>.

10.2

General Technical Data of the Laser

Operating range

Operating range (diameter):

Rugby 670/680: 800 m/2,600 ft

Self-levelling accuracy

Self-levelling accuracy: ±1.5 mm at 30 m (±1/16" at 100 ft)

Self-levelling accuracy is defined at 25°C (77°F)

Self-levelling range

Self-levelling range: ±5°

Rotation speed

Rotation speed: 10 rps

Grade range

Grade range:

Rugby 670 (single grade):

X-axis ±8.00%

Rugby 680 (dual grade):

X-axis and Y-axis ±8.00%

Laser Dimensions

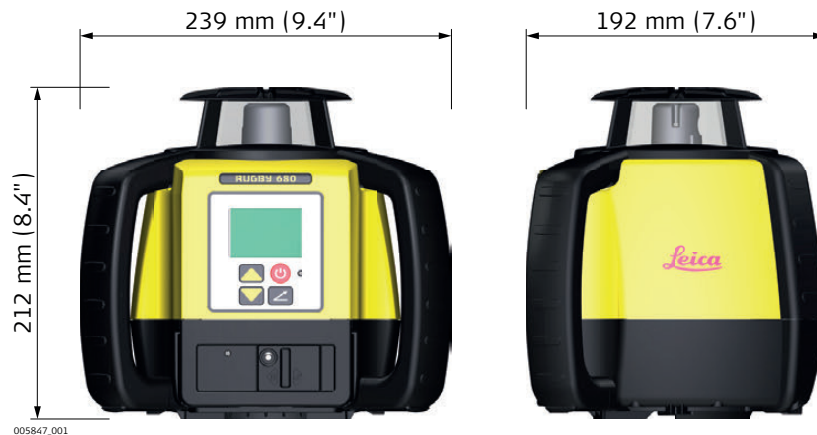

Weight

Rugby 670/680 weight with battery: 2.56 kg/5.6 lbs.

Internal battery

Type	Operating times* at 20°C
A600 Lithium-Ion (Li-Ion Pack)	40 h
Alkaline (four D-cells)	60 h

*Operating times are dependent upon environmental conditions.



Charging the Li-Ion battery pack takes a maximum of five hours.



Use only high quality alkaline batteries to achieve operating time.

Environmental specifications**Temperature**

Operating temperature	Storage temperature
-20°C to +50°C (-4°F to +122°F)	-40°C to +70°C (-40°F to +158°F)

Protection against water, dust and sand

Protection
IPX7
Dust tight Protected against continuous immersion in water.

A100 Lithium-Ion charger

Type:	Li-Ion battery charger
Input voltage:	100 V AC-240 V AC, 50 Hz-60 Hz
Output voltage:	12 V DC
Output current:	3.0 A
Polarity:	Shaft: negative, Tip: positive

A600 Lithium-Ion battery pack

Type:	Li-Ion battery pack
Input voltage:	12 V DC
Input current:	2.5 A
Charge time:	5 hours (maximum) at 20°C

Description**Lifetime Manufacturer's Warranty**

Warranty coverage for the entire usage time of the product. Free charge repair or replacement for all products that suffer defects as a result of faults in materials or manufacturing, for the entire life of the product.

Three Years No Costs

Guaranteed service should the product become defective and require servicing under normal conditions of use, as described in the user manual, at no additional charge.

To receive the "three years no cost" period, the product must be registered at <http://www.leica-geosystems.com/registration> within 8 weeks of the purchase date. If the product is not registered, a two year warranty applies.

Accessories for power supply

A100 - Li-Ion Charger (790417)

The A100 Li-Ion charger comes complete with four separate AC adaptors.

A130 - 12 Volt Battery Cable (790418)

The A130 12 volt battery cable connects the Rugby to a standard 12 volt automotive battery as a backup for the unit's battery. It is only usable with the rechargeable battery pack. Length: 4 metres/13 feet.

A140 - Car Adapter Cable (797750)

The A140 car adapter cable connects the Rugby to a standard automotive accessory jack as a backup for the unit's battery or to charge in a vehicle. It is only usable with a rechargeable battery pack. Length: 2 metres/6.5 feet.

A150 - Alkaline Battery Pack (790419)

The A150 alkaline battery pack is included as part of the standard alkaline package. It can also be purchased separately to be used as a backup for rechargeable models. Batteries required: Four D-cell type alkaline.

A600 - Li-Ion Battery Pack (790415)

The A600 Li-Ion battery pack is included as part of the standard rechargeable package. It can also be purchased separately as an upgrade to the alkaline battery pack. It is necessary to also purchase the A100, Li-Ion battery charger to complete the Li-Ion battery solution.

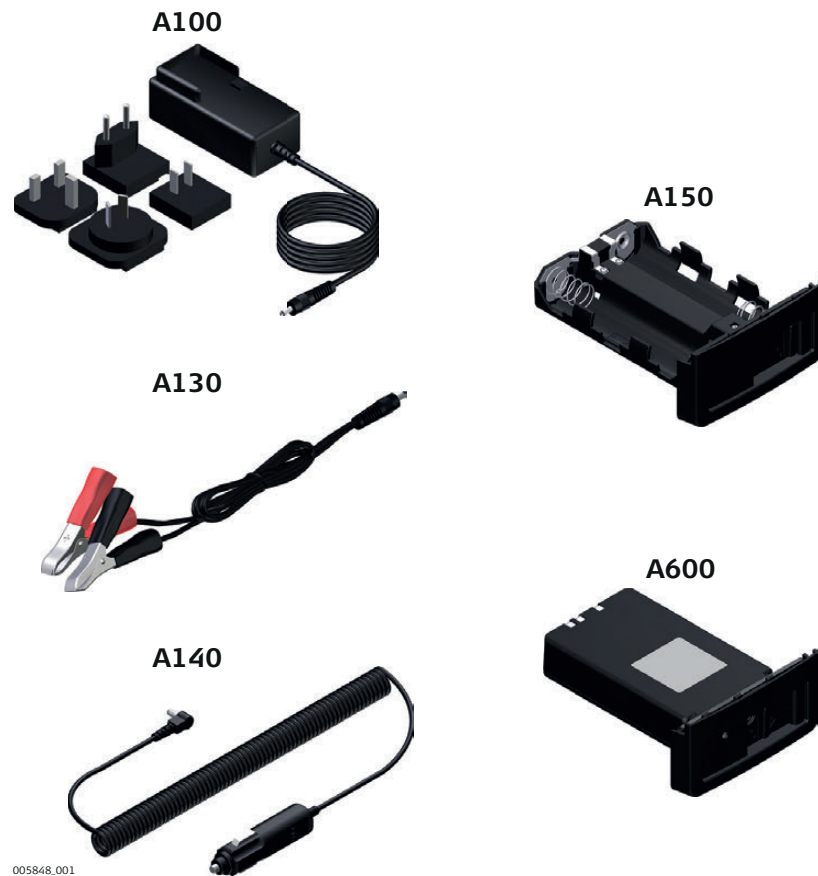

Index

A	
Accessories	45
Accuracy	
Self-levelling	42
Accuracy Adjustment	35
Adjust	
Level Accuracy	36
Applications	
Checking Grades	30
Entering Grades	31
Setting Forms	29
B	
Batteries	
Charging, first-time use	32
Operation, Discharging	32
Battery	
Change alkaline batteries	34
Change Li-Ion battery pack	33
Charge	32
Technical data	42
Battery Charger	
Technical data	43
Battery Pack	
Technical data	43
Buttons	18
C	
Classic Receiver	25
D	
Definition of Use	7
Description of the system	14
Dimensions	
Of laser	42
Documentation	2
E	
Environmental specifications	
Laser	43
F	
FCC Statement	12
G	
Grade range	42
I	
Instrument	
Technical Data	42
Intended use	7
L	
Laser	
Classification	10
Dimensions	42
Laser Classification	
Rugby	10
Level Accuracy	
Adjust	36
Check	35
Li-Ion battery	43
Storage	40
M	
Menu	
Rod Eye	27
O	
Operating range	42
R	
Range	
Self-levelling	42
Responsibilities	7
Rod Eye	
Instrument components	25, 27
Menu	27
Rotation speed	42
S	
Safety Directions	6
Setup	
Instrument on tripod	16
Specifications, environmental	
Instrument	43
T	
Temperature	
Laser	
Operating	43
Storage	43
Temperature, charging internal battery	32
Troubleshooting	39
U	
User Manual	
Validity of	2
W	
Warranty	44
Weight	
Instrument	42

799794-1.0.0en

Original text

Published in Switzerland

© 2013 Leica Geosystems AG, Heerbrugg, Switzerland

Leica Geosystems AG

Heinrich-Wild-Strasse

CH-9435 Heerbrugg

Switzerland

Phone +41 71 727 31 31

www.leica-geosystems.com

- when it has to be **right**

Leica
Geosystems