

BT-610 MANUAL



Met One Instruments, Inc

Corporate Sales & Service: 1600 NW Washington Blvd. Grants Pass, OR 97526

Tel (541) 471-7111 Fax (541) 471-7116

www.metone.com service@metone.com

Copyright Notice

BT-610 Manual

© Copyright 2012 Met One Instruments, Inc. All Rights Reserved Worldwide. No part of this publication may be reproduced, transmitted, transcribed, stored in a retrieval system, or translated into any other language in any form by any means without the express written permission of Met One Instruments, Inc.

Technical Support

Should you require support, please consult your printed documentation to resolve your problem. If you are still experiencing difficulty, you may contact a Technical Service representative during normal business hours—7:00 a.m. to 4:00 p.m. Pacific Time, Monday through Friday.

Voice: (541) 471-7111

Fax: (541) 471-7116

E-Mail: service@metone.com

Mail: Technical Services Department
Met One Instruments, Inc.
1600 NW Washington Blvd.
Grants Pass, OR 97526

NOTICE



CAUTION—Use of controls or adjustments or performance of procedures other than those specified herein may result in hazardous radiation exposure.



WARNING—This product, when properly installed and operated, is considered a Class I laser product. Class I products are not considered to be hazardous.

There are no user serviceable parts located inside the cover of this device.

Do not attempt to remove the cover of this product. Failure to comply with this instruction could cause accidental exposure to laser radiation.

Table of Contents

1. Introduction	5
2. Setup	5
2.1. Unpacking.....	5
2.2. Layout.....	8
2.3. Default Settings	10
2.4. Initial Operation	10
3. User Interface	11
4. Operation	11
4.1. Power Up.....	11
4.2. Printer Operation	12
4.3. Operate Screen	13
4.3.1. Favorites	13
4.3.2. Sampling	14
4.3.3. Sample Status.....	14
4.3.4. Sample History.....	14
4.3.5. Warnings / Errors	15
4.4. Sample Related Functions	15
4.4.1. Starting/Stopping.....	15
4.4.2. Real-Time Output.....	15
4.4.3. Sample Mode	15
4.4.4. Sample Time	15
4.4.5. Hold Time.....	15
4.4.6. Sample Timing	16
5. Main Menu.....	16
5.1. Edit Main Menu Items.....	17
5.2. Sample Setup Screen.....	17
5.2.1. Location Number.....	17
5.2.2. Sample Time	17
5.2.3. Hold Time.....	17
5.2.4. Samples	18
5.3. Settings Screen	18
5.3.1. Count Units	18
5.3.2. Temperature.....	18
5.4. Serial Screen	18
5.4.1. Report Type	19
5.4.2. Baud Rate	19
5.4.3. Serial Output Mode	19
5.5. Printer Screen.....	19
5.5.1. Printer.....	19
5.6. Favorites Screen	19
5.6.1. Favorites Mode (ON/OFF)	20
5.6.2. Favorites Sizes (SIZE)	20
5.6.3. Favorites Alarm Limits (ALARM).....	20

5.6.4.	Favorites Analog Output Scaling (A-SCALE)	20
5.7.	Calibrate Flow Screen	20
5.8.	Set Sizes Screen	21
5.9.	Set Clock Screen	21
5.10.	Set Contrast Screen	22
5.11.	Password Screen	22
5.12.	About Screen	23
6.	Data Menu	23
6.1.	Copy to USB Drive	23
6.2.	Recall Data	24
6.3.	Printing Sample Data	24
6.4.	Memory Screen	25
6.4.1.	View Available Memory	25
6.4.2.	Clearing memory	25
7.	Charging the Battery	26
8.	Serial Communications	26
8.1.	Commands	27
8.1.1.	Computer Mode	27
8.1.2.	User Mode	27
8.2.	Real Time Output	28
8.3.	Comma Separated Value (CSV)	28
8.4.	Printer Style	29
8.5.	RS485 Networking	30
9.	Maintenance	31
9.1.	Service Schedule	31
9.1.1.	Zero Count Test	31
9.1.2.	Flow Rate Test	31
9.1.3.	Annual Calibration	32
9.2.	Flash Upgrade	32
10.	Troubleshooting	32
11.	Specifications	33
12.	Warranty / Service	34

1. Introduction

The BT-610 is a portable airborne particle counter with a small stable footprint. This allows you to move it around and set it down rather than holding it in your hand while sampling. The large character backlit LCD display provides easy viewing from distances exceeding 3 meters.

Other key features include:

- 6 particle sizes (Defaults: 0.3, 0.5, 1.0, 2.0, 5.0 and 10 μm)
- User size settings (0.1 μm steps from 0.3 to 2 μm , 0.5 μm steps from 2 to 10 μm)
- 2 Favorite sizes (including count alarm limits and analog output)
- Copy data to USB memory stick
- On Board Printer
- Serial communications (USB, RS232, RS485)
- Internal battery pack for portable operation (8 hours continuous)

2. Setup

The following sections cover unpacking, layout and performing a test run to verify operation.

2.1. Unpacking

When unpacking the BT-610 and accessories, inspect the carton for obvious damage. If the carton is damaged notify the carrier. Unpack and inspect the contents of the shipping container.

The BT-610 is shipped with the standard items shown in Figure 1. Contact the supplier if any items are missing. Figure 2 shows optional equipment which can be purchased separately.

ATTENTION:

The included USB drivers must be installed before connecting the BT-610 USB port to your computer. If the supplied drivers are not installed first, Windows may install generic drivers that are not compatible with this product.

To install USB drivers:

Insert the Comet CD. The install program should run automatically and display the screen below. If an AutoPlay pop-up window appears, select "Run AutoRun.exe". Finally, select "USB Drivers" to start the install process.



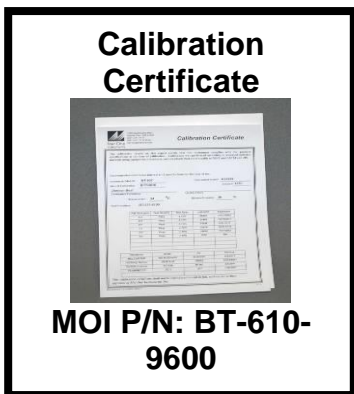
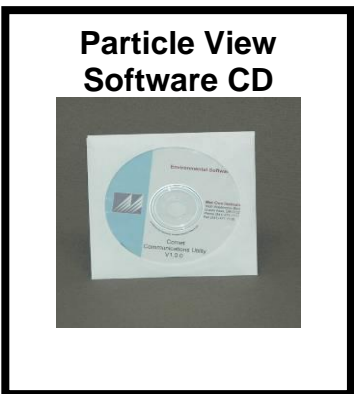
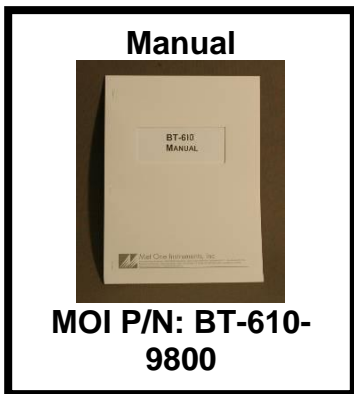

Figure 1 – Standard Equipment

BT-610 Optional Equipment

Temperature & Humidity Probe



MOI P/N: G3120

Dwyer™ Ball Flow Meter



MOI P/N: 9801

Serial Cable



MOI P/N: 550065

Figure 2 – Optional Equipment

2.2. Layout

Figure 3 shows the layout of the BT-610 and the following table provides a description of the components.



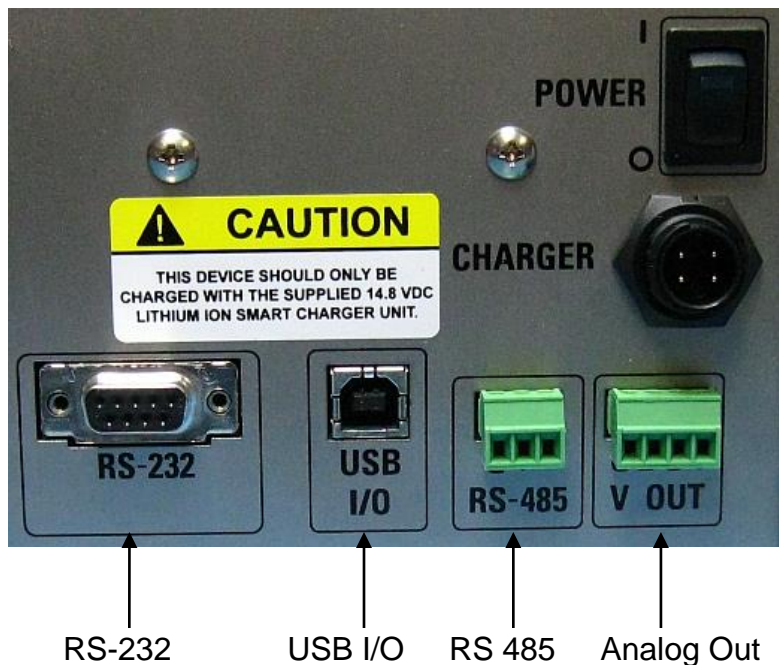

Figure 3 – BT-610 Layout

Component	Description
Display	4X20 character LCD display (backlit)
Keyboard	8 key membrane keypad
Printer	On Board thermal printer
Power Switch	Switch that turns the BT-610 on or off (up for on).
Charger Jack	Input jack for the battery charger. This jack charges the internal battery pack and provides continuous operating power for the unit.
Inlet Nozzle	Ambient air inlet nozzle. Connect isokinetic probe to reduce turbulence in the air sample.
T/RH Connector	Mating connector for the optional external Temperature/RH sensor.
USB I/O	USB communication port
USB Drive	Export sample data to USB memory stick
RS-232 Serial Port	Connection used for serial communication
RS-485 Serial Port	Connection used for long distances (4,000 feet) or multi-drop (32 units)
Analog out	Two analog output channels (0-5V = 0 – FS Counts). FS (Full Scale) is settable from 0 to 9,999,999 counts.

2.3. Default Settings

The BT-610 comes with the user settings configured as follows.

Parameter	Value
Sample Location	1
Sample Mode	Single
Sample Time	60 seconds
Sample Hold Time	0 seconds
Count Units	CF
Temperature Units	C
Baud Rate	9600
Serial Output	RS-232

2.4. Initial Operation







Before operating the BT-610 for the first time, it is recommended that the unit be fully charged. Information regarding battery charging is found in Section 7. Complete the following steps to verify proper operation.

1. Press the top of the power switch to turn on power.
2. Observe the Startup Screen for 2 seconds then the Operate Screen (Section 4.2)
3. Press Start / Stop key. The BT-610 will sample for 1 minute and stop.
4. Observe the counts on the display
5. Use the up / down arrows to view other sizes
6. The unit is ready for use.

3. User Interface

The BT-610 user interface is composed of an 8 button keypad and a LCD display. The following table describes keypad functionality.

Note: Some keys have more than one function.

Key	Description
	<ul style="list-style-type: none">Starts or stops a sample (Operate or Main Menu Screen).Starts USB data transfer (Copy to USB Drive Screen).Starts printing data (Print Data Screen).Recalls the selected data (Recall Data Screen).
	<ul style="list-style-type: none">Loads the Data Menu Screen.
	<ul style="list-style-type: none">Loads the Main Menu Screen.Loads the Operate Screen when in the Main Menu Screen.Cancel editing. Returns the field to the original value before editing began.
	<ul style="list-style-type: none">Loads the screen associated with menu item.View history when Operate Screen is displayed.Stops editing a field and saves the changed value.
	<ul style="list-style-type: none">Navigates up / down when not editing.Modifies field when editing.
	<ul style="list-style-type: none">Navigates left / right

4. Operation

The following sections cover the basic operation.

4.1. Power Up

The BT-610 power is controlled by a switch located on the back of the unit. To power up the unit move the switch to the on position (up).

The first screen shown on power up is the Startup Screen (Figure 4). This screen displays the product type and company website for approximately 2 seconds before loading the Operate Screen.

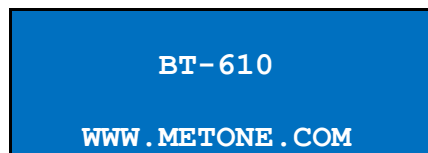

Figure 4 – Startup Screen

4.2. Printer Operation



Figure 5 – Open Printer Door

If there is no paper loaded in the printer, the indicator light on the bottom right of the printer will glow orange. To load paper into the printer, lift the printer door latch from the center until the door opens.



Figure 6 – Install Paper and Close Printer Door

Place a roll of paper in the printer bay with the free end up and coming from the back of the roll. Close the printer door and the green indicator light should light. Press the white button on printer to manually advance the paper. See Section 5.5 for Printer Operation.

4.3. Operate Screen

The Operate Screen displays the date/time, sample status, current sample data and previous sample data. Figure 7 shows the Operate Screen.

15	AUG'10	11:23	L001
0.3 μ		0	CF
0.5 μ		0	CF
0.7 μ		0	CF
1.0 μ		0	CF
2.0 μ		0	CF
5.0 μ		0	CF

Figure 7 – Operate Screen

The top line of the Operate Screen is reserved for the normal header (date, time and location) or status/alarm messages depending upon the machine status. The top line remains stationary while the other 3 lines scroll to display the full list. Temp/RH data will follow the count data when the RH/Temp probe is connected.

The Operate Screen normally displays 6 particle sizes; however, the BT-610 also offers a Favorites mode which configures the unit to display and print any two of the six standard sizes (see Section 4.3.1).

Particle counts units are user selectable. The selections include: Total counts (TC), particles per liter (/L), particles per cubic foot (CF) and particles per cubic meter (M3). Ambient temperature can be displayed in units of Celsius (C) or Fahrenheit (F). Both unit settings are discussed in Section 5.2.4.

4.3.1. Favorites

The Favorites setting eliminates the need to scroll the display when monitoring two non-adjacent sizes (see Section 5.4). The Favorites setting configures the display and printer for two sizes however the BT-610 still counts and buffers all six particle sizes. Sample data for all six channels is available via the serial port (Section 8) or by viewing count history on the display (Section 4.3.4). Figure 8 shows the Favorites Operate Screen with RH/Temp probe attached.

18	AUG'06	11:23	L001
0.3 μ		0	CF
5.0 μ		0	CF
Temp	24°C	RH	40 %

Figure 8 – Favorites Operate Screen w/ RH/Temp

4.3.2. Sampling

The Operate Screen displays current sample information when the unit is sampling (real time data). Concentration values (/L, CF, M3) are time dependent so these values may fluctuate early in the sample; however, after several seconds the measurement will stabilize. Longer samples (e.g. 60 seconds) will improve concentration measurement accuracy. Figure 9 shows the Operate Screen while sampling with RH/Temp probe attached.

COUNTING...	58	L001
0.3μ	29,780	CF
0.5μ	1,400	CF
TEMP	24°C RH	40%

Figure 9 – Operate Screen (Sampling)

4.3.3. Sample Status

The top line of the Operate Screen displays the status of the BT-610 while the unit is sampling. The following table shows the various status messages and their meaning:

Status	Description
STARTING...	Starting the sample and waiting for the count system to initialize.
COUNTING... 58	BT-610 is sampling. The time remaining is displayed to the far right.
HOLDING...10	BT-610 is in auto mode and is waiting for the hold time to finish. The time remaining is displayed to the far right.

4.3.4. Sample History

Sample history (previous data) can be viewed on the Operate Screen when the unit is stopped (not sampling). To view sample history, press the Enter key from the Operate Screen. The unit will display the last sample event (newest record) and display “←” on the right side of the display (see Figure 10) to indicate history data. Press ◀ or ▶ to move through sample history one record at a time (◀ displays older events, ▶ displays newer events). Press the Enter key at any time to return to the Operate Screen. Press Start at any time to start a new sample.

Sample history will display 2 channels in Favorites mode. To view other channels, change favorite sizes or disable Favorites mode (Section 5.4) before you view history.

15 AUG' 10 11:23	L001
0.3μ	0 CF ←
0.5μ	0 CF ←
0.7μ	0 CF ←

Figure 10 – History Screen

4.3.5. Warnings / Errors

The BT-610 displays warning/error messages on the top line of the Operate Screen. These messages alternate with the normal date/time header. The following table lists the warning/error messages:

Display Message	Description
<COUNT ALARM>	Count alarm. The count is \geq the alarm limit.
LOW BATTERY!	Low battery warning. Less than 15 minutes of normal operation remaining. Recharge the battery
FLOW ERROR!	The sample flow rate is not within $\pm 10\%$ of the nominal 0.1 CFM flow rate.
SENSOR ERROR!	Particle sensor error.

4.4. Sample Related Functions

The following sub-sections cover BT-610 sample related functions.

4.4.1. Starting/Stopping

To start or stop a sample, press the START/STOP key. A sample event can be manually started or stopped from either the Operate Screen or the main menu.

4.4.2. Real-Time Output

BT-610 provides real-time output on the serial port at the end of each sample. The format of the output is controlled by the Serial Output setting (Section 5.4).

4.4.3. Sample Mode

The sample mode controls single sample or continuous sampling. The SINGLE setting configures the unit for a single sample. The REPEAT setting configures the unit for continuous sampling. Entering a number of samples will cause the BT-610 to collect that number of samples and then stop sampling.

4.4.4. Sample Time

The sample time determines the amount of time that counts are accumulated. The length of the sample is user settable from 1 – 9999 seconds and is discussed in section 5.2.2.

4.4.5. Hold Time

The hold time is used when the sample mode is set to repeat (continuous sample). The hold time represents the time from the completion of the last sample to the start of the next sample. The hold time is user settable from 0 – 9999 seconds and is discussed in section 5.2.3.

4.4.6. Sample Timing

The following figures depict the sample timing sequence for both single and repeat sampling modes. Figure 11 shows the timing for single sample mode. Figure 12 shows the timing for repeat sample mode.



Figure 11 – Single Mode Sample

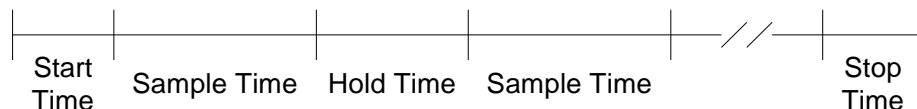

Figure 12 – Repeat Mode Sample

5. Main Menu

The Main Menu is accessible by pressing the menu key on the Operate Screen. The table below shows the Main Menu items. Press ▲ or ▼ to navigate to a menu item then press Enter to display a screen where you can view or change item setting(s).

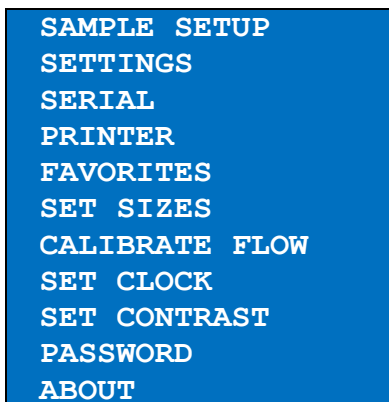

Figure 13 – BT-610 Main Menu

Menu Item	Description	Press Enter to navigate to...
SAMPLE SETUP	View / change location number, auto / single mode, sample time and hold time.	Sample Setup Screen
SETTINGS	View / change volume (count units) and temperature units °C / °F.	Settings Screen
SERIAL	View / change Serial Report type, Baud Rate and serial mode.	Serial Screen
PRINTER	View / change Printer enable setting	Printer Screen
FAVORITES	Set count alarm limits for 2 particle sizes	Count Alarm Screen
SET SIZES	Set particle sizes	Set Sizes Screen
CALIBRATE FLOW	Calibrate the sample flow rate	Flow Screen

SET CLOCK	Set the date and time.	Set Clock Screen
SET CONTRAST	Adjust the display contrast.	Set Contrast Screen
PASSWORD	View / set the user password.	Password Screen
ABOUT	Display firmware version and serial number.	About Screen

5.1. Edit Main Menu Items

To change settings, press Menu to display the Main Menu, press ▲ or ▼ to navigate to the desired item and press Enter to display the item view/edit screen.

To edit pick list items (e.g. Sample Setup – Single/Repeat), press ▲ or ▼ to navigate to the item. Press Enter to select the item. Press ▲ or ▼ to change the setting. Press ENTER to save the setting or ESC to cancel and return to the original value.

To edit numeric values (e.g. Count Alarms - Alarm Limit), press ▲ or ▼ to navigate to the item. Press Enter to select the item. Press ▲ or ▼ to increment or decrement a value. Press ◀ or ▶ to select the next digit. Press ENTER to save the value or ESC to cancel and return to the original value.

Note: If the user password is set, the user password must be entered to gain access to the main menu.

5.2. Sample Setup Screen

Figure 14 shows the Sample Setup Screen. The 4 parameters are covered in the following sections.

```

LOCATION:    001
SAMPLE TIME: 0060
HOLD TIME:  0000
SAMPLES:   SINGLE

```

Figure 14 – Sample Setup Screen

5.2.1. Location Number

The location number is used to assign a unique number to a location or area. This important field is included in sample data records (display, printer and serial output).

5.2.2. Sample Time

The sample time determines the amount of time that counts are accumulated while the pump is running. The length of the sample is user settable from 1 – 9999 seconds.

5.2.3. Hold Time

The Hold time is the time between samples when sampling in Repeat mode (continuous) or when sampling a given number of samples. The Hold time is user settable from 0 – 9999 seconds. The pump will remain on during the hold period if the Hold time is 60 seconds or less. The pump will stop after each sample, and start a few seconds before the next sample, if the Hold time is greater than 60 seconds. Hold times greater than 60 seconds will increase pump life.

5.2.4. Samples

The samples setting controls the number of samples to take as illustrated below.

Selection	Description
REPEAT	Repeat configures the unit for continuous sampling.
SINGLE	Single configures the unit for a single sample.
002-9999	Configures the unit to take N samples.

5.3. Settings Screen

Figure 15 shows the Settings Screen. These parameters are covered in the sections immediately following.

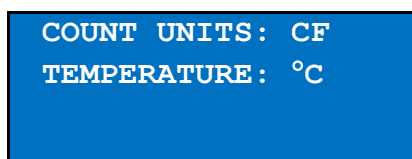

Figure 15 – Settings Screen

5.3.1. Count Units

The BT-610 supports total counts (TC), particles per liter (/L), particles per cubic foot (CF) and particles per cubic meter (M3). Particle count information updates while the unit is sampling. Concentration values (/L, CF, M3) are time dependent so these values may fluctuate early in the sample; however, after several seconds the measurement will stabilize. Longer samples (e.g. 60 seconds) will improve concentration measurement accuracy.

5.3.2. Temperature

The BT-610 displays temperature in Celsius (C) or Fahrenheit (F).

5.4. Serial Screen

Figure 16 – Serial Screen shows the Serial Screen. The 3 parameters are covered in the sections immediately following.

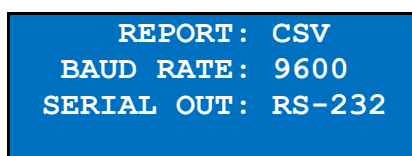

Figure 16 – Serial Screen

5.4.1. Report Type

The Report setting determines the output format for the Serial Port. The choices are NONE, CSV and PRINTER.

When set to NONE, the unit will not automatically output the reading at the end of a sample to the Serial Port. CSV is a Comma Separated Values output format suitable for importing into a spreadsheet. PRINTER is the same format as the screen and panel mounted printer.

This setting does not affect the panel mounted printer which always prints in PRINTER format.

5.4.2. Baud Rate

Use the Baud Rate selection to set the serial communications baud rate. BT-610 communicates at baud rates from 300 – 38400.

5.4.3. Serial Output Mode

The Serial Out setting controls the behavior of the BT-610 serial output. The modes are RS232, RS485, Printer or Network (see Section 7 for serial communication protocol). The following table lists the Serial Output settings and describes their meanings.

Serial Out Setting	Description
RS232	RS232/USB communication.
RS485	RS485 communication.
NETWORK	RS485 communication with all serial output suppressed unless specifically addressed.

5.5. Printer Screen

Figure 17 shows the Printer Screen.

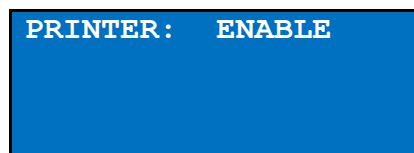

Figure 17 – Printer Screen

5.5.1. Printer

The Printer setting selects whether to ENABLE or DISABLE the panel mounted printer for automatic output at the end of each sample. The panel mounted printer always prints in Printer format regardless of the Serial Output format specified.

5.6. Favorites Screen

The Favorites mode eliminates the need to scroll the display when monitoring two non-adjacent sizes. The Favorites mode also provides count alarm limits and analog output scaling for the Favorites (2 count channels). The Favorites mode controls the display

(real time and history) and printer format. The CSV serial output includes all 6 sizes. Figure 18 – Favorites shows the Favorites screen.

FAVORITES ON		
SIZE	ALARM	A-SCALE
0.3	0500000	0500000
5.0	0500000	0500000

Figure 18 – Favorites

5.6.1. Favorites Mode (ON/OFF)

Enables or disables Favorites mode (On = Enabled, Off = Disabled).

5.6.2. Favorites Sizes (SIZE)

Select 2 of the 6 standard sizes. Favorite 1 is 0.3 μm in Figure 18 (above).

5.6.3. Favorites Alarm Limits (ALARM)

Favorites count alarm limit. A zero (0) value disables the count alarm. The alarm is active when the count is equal to or greater than the alarm limit. The maximum alarm limit value is 9,999,999.

Alarm values do not change with the count units setting (TC, /L, CF, M3). In other words, a value of 1,000 will alarm at 1,000 counts or 1,000 particles per cubic foot or 1,000 particles per liter depending on the count unit setting.

5.6.4. Favorites Analog Output Scaling (A-SCALE)

Favorites analog output scaling (0 – 5 volts = 0 – VALUE). The maximum scale value is 9,999,999. A zero (0) value will configure the analog output for a digital or binary alarm (0 volts = normal, 5 volts = alarm). The alarm limit for this binary mode is configured in Section 5.6.3 above.

Figure 19 shows the analog output connector pin assignments. GND pins are signal ground. A1 and A2 are Analog Output 1 and Analog Output 2 which are associated to Favorite 1 and Favorite 2 respectively (see Section 5.6.2).

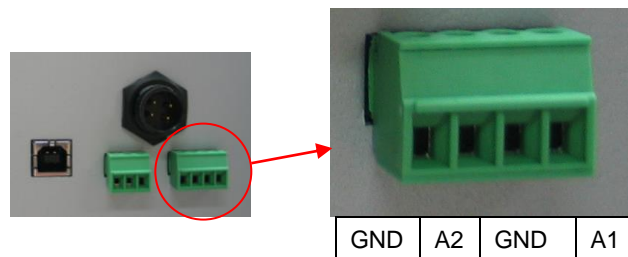

Figure 19 – Analog Output Connector

5.7. Calibrate Flow Screen

The BT-610 has a factory calibrated flow rate of 0.1 CFM (2.83 LPM). Under normal circumstances, the integrated flow control system will maintain flow within +/- 5% of this

flow rate. Use the following procedure to calibrate the flow rate when a periodic flow rate check (Section 9.1.2) indicates a flow rate error greater than +/- 5%.

1. Connect a reference flow meter to the inlet fitting on the top of the unit.
2. Access the Calibrate Flow screen by pressing Menu then select Calibrate Flow. The pump will start automatically when you enter the Calibrate Flow screen and stop when you leave the screen. The system will wait several seconds for the flow to stabilize. During this time, the unit will display "Waiting..."
3. Afterwards, use the up and down arrow keys to adjust the flow until the reference flow meter reads within tolerance. You will need to wait a few seconds after each adjustment for the flow system and the reference meter to stabilize. Figure 20 shows an example of the Calibrate Flow Screen.
4. When the desired flow rate is reached, press ENTER to set the calibration.
5. Exit the Calibrate Flow screen by pressing the ESC button (the pump will stop).

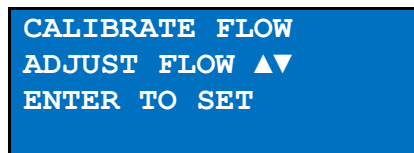

Figure 20 – Calibrate Flow

5.8. Set Sizes Screen

The BT-610 has six standard factory calibrated particle sizes. These standard sizes will support most applications and provide the best size accuracy (+/- 10%). This unit also supports custom sizes. These sizes are configured using the Set Sizes Screen (Figure 21). Custom size thresholds are interpolated using the standard size calibration curve. Therefore, the size accuracy for custom sizes is somewhat reduced (+/- 15%).

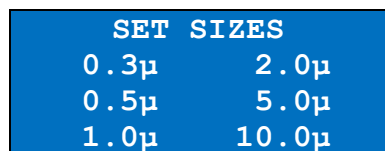

Figure 21 – Set Sizes Screen

The unit sorts sizes from small to large after each size change. Duplicate sizes are not allowed. Any attempt to set two or more sizes to the same value will result in a "DUPLICATE SIZES!" warning message.

5.9. Set Clock Screen

To set the date and time select SET CLOCK from the menu. Figure 22 shows the Set Clock Screen and the following table describes the date and time formats.

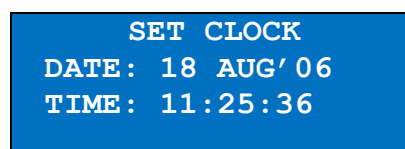

Figure 22 – Set Clock Screen

Date / Time Formats		
Date	dd mmm'yy	dd=day, mmm=month, yy=year
Time	hh:mm:ss	Hh=hours, mm=minutes, ss=seconds

5.10. Set Contrast Screen

Press ◀ or ▶ to improve display quality. Press Enter to save the setting or ESC to cancel the change. Figure 23 shows the Set Contrast Screen.

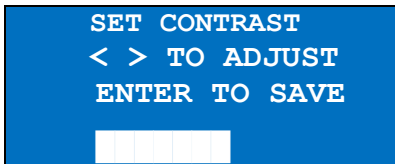

Figure 23 – Set Contrast

5.11. Password Screen

The user settings in the BT-610 can be password protected to prevent unauthorized access. This helps maintain the integrity of the data.

The PASSWORD setup screen is used to set, change, or remove the 4-digit numeric password that is used to restrict access to these areas including the setup menu. The default password is 0000. This disables the password and allows unrestricted access to all the password-controlled functionality.

If the password is changed to any value between 0001 and 9999, it will subsequently be required for access to these screens.

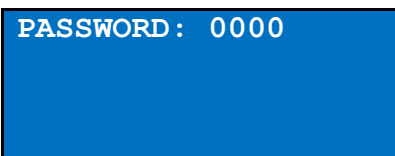
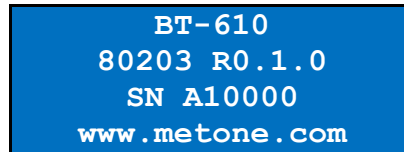

Figure 24 – Password Screen

5.12. About Screen

Figure 25 shows the About Screen. The About Screen shows the firmware version and programmable logic version on the second line. Press ▲ or ▼ to toggle between the two version numbers. The serial number is shown on the third line.



```
BT-610
80203 R0.1.0
SN A10000
www.metone.com
```

Figure 25 – About Screen

6. Data Menu

To access data options (copy data, view available memory, recall data and print data), simply press the Data key to navigate to the Data Screen. Figure 26 shows the Data Screen.

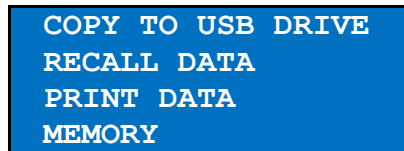

```
COPY TO USB DRIVE
RECALL DATA
PRINT DATA
MEMORY
```

Figure 26 – Data Screen

6.1. Copy to USB Drive

Figure 27 shows the Copy Data Screen. The BT-610 will copy all data from the displayed date/time to current time. Initially, the date/time will be the first sample record so all records will be copied. To reduce transfer time, press Enter and change the date/time to a more recent date/time.

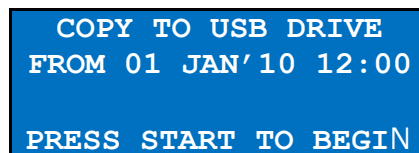

```
COPY TO USB DRIVE
FROM 01 JAN'10 12:00
PRESS START TO BEGIN
```

Figure 27 – Print Data Screen

Press the Start button to initiate the copy process. Press the ESC button to cancel the copy process and return to the Data menu. The following screen is displayed during the copy process (Figure 28).

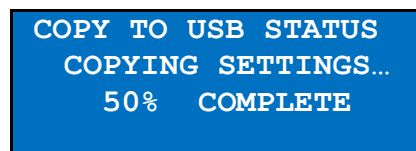

```
COPY TO USB STATUS
COPYING SETTINGS...
50% COMPLETE
```

Figure 28 – USB Status Screen

6.2. Recall Data

Stored sample events can be viewed from the Operate Screen but this requires navigating one record at a time to reach a desired record. The Recall Data Screen provides a way to quickly navigate to a record based on time. Figure 29 shows the Recall Data Screen.

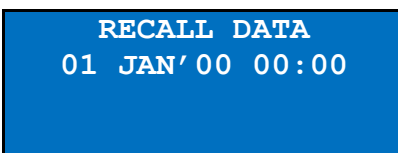

Figure 29 – Recall Data Screen

To recall data, enter the desired date/time and select the START/STOP button. The unit will recall the data from the date/time entered (if an exact match is found) or the next most recent data available. The unit will display “←” on the right side of the display to indicate history data.

6.3. Printing Sample Data

Stored sample events can be printed via the serial port within a user selected range. To access the printing feature, press the Data key then select PRINT DATA from the menu. Figure 30 shows the Print Data Screen.

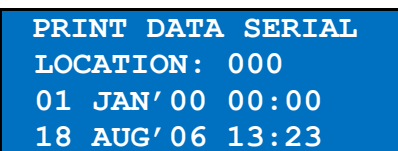

Figure 30 – Print Data Screen

This screen allows the user to choose whether the output goes to the panel mounted printer or the serial port. The panel mounted printer always prints in PRINTER output format. The output format for the serial port is selected in the Serial Screen.

Edit the location and time range to select which sample events to print. The following table describes the settings.

Setting	Description
PRINT DATA	Pick SERIAL or PRINTER for where to send the output.
LOCATION	The location ID of the sample events to print. Setting location to 000 prints all locations. Settable from 0 - 999
01 JAN'00	The date/time to begin printing sample events from.
18 AUG'06	The date/time to stop print samples.

After the print settings have been selected, press the START button. The Printing Status screen is displayed. Figure 31 shows the Printing Status screen as it would look when finished.

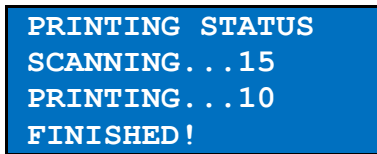

```
PRINTING STATUS
SCANNING...15
PRINTING...10
FINISHED!
```

Figure 31 – Printing Status Screen

Pressing the ESC button cancels the data printing and loads the menu. The format of the print is dependent upon the report setting (Section 5.2.4).

6.4. Memory Screen

The BT-610 memory is composed of a single file which contains the data from sample events. Every time a sample is completed, the BT-610 stores that data into the memory. The BT-610 memory is circular, meaning when the memory is full, the unit will start overwriting the oldest saved samples with new samples. BT-610 provides the user the ability to view the memory usage as well as clear the memory.

6.4.1. View Available Memory

Memory Screen is used to view available memory or to clear the memory. The Memory Screen is accessed by selecting MEMORY from the Data Menu. Figure 32 shows the Memory Screen.

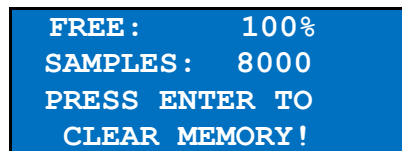

```
FREE: 100%
SAMPLES: 8000
PRESS ENTER TO
CLEAR MEMORY!
```

Figure 32 – Memory Screen

FREE shows the percent of space available for data storage. When 0% is displayed, memory is full and the oldest data will be overwritten by new data. SAMPLES shows the number of samples which can be stored in memory before the memory is full. When 0 is displayed, memory is full and the oldest data will be overwritten by new data.

6.4.2. Clearing memory

To clear memory, press the ENTER key while viewing the Memory Screen. This will delete all the sample events in memory. A warning screen will be displayed to prevent accidental erasure.

7. Charging the Battery

Caution:

The provided battery charger is designed to work safely with this device. Do not attempt to connect any other charger or adapter to this device. Doing so may result in equipment damage.

To charge the battery, connect the battery charger to an AC power outlet and the DC plug to the socket on the back of the BT-610. The battery charger is universal and will work with power line voltages of 100 to 240 volts, 50 to 60 Hz. The battery charger LED indicator will be Red when charging and Green when fully charged. A discharged battery pack will take approximately 3 hours to fully charge.

When fully charged the battery inside the BT-610 will power the unit for about 8 hours of continuous sampling. Under normal operation, the battery will power the unit for about 24 hours. For continuous operation, operate the unit with the battery charger attached. Charge the battery before storing the BT-610. Storing a discharged battery will degrade its performance.

8. Serial Communications

BT-610 provides serial communications via USB, DB9 and terminal strip connectors located on the back of the unit. The following sections discuss the various serial communications.

ATTENTION:

The USB drivers **must** be installed before connecting the BT-610 USB port to your computer. If the supplied drivers are not installed first, Windows may install generic drivers that are not compatible with this product.

To install USB drivers:

Insert the Comet CD. The install program should run automatically and display the screen below. If an AutoPlay pop-up window appears, select "Run AutoRun.exe". Finally, select "USB Drivers" to start the install process.



8.1. Commands

The BT-610 provides serial commands for accessing stored data and settings. All commands are terminated by a carriage return. Also, these commands are not case sensitive. The following table lists the available commands. These commands are available via USB, RS232 and RS485 hardware interfaces. The settings (baud rate, parity and stop bits) must match the computer setting for proper communication regardless of the hardware interface type (USB, RS232 or RS485).

8.1.1. Computer Mode

Computer Mode is intended for connecting the unit directly to a data logger or computer program such as Comet. This is the default mode of the unit.

In Computer Mode, all commands are preceded by the <Esc> (ASCII 27) character. No characters are echoed back to the user when entering commands. All commands are executed using the <ENTER> key.

Each time the <Esc> key is pressed, the unit will reset to Computer Mode and start the command input over.

8.1.2. User Mode

User Mode is intended for direct user interaction. In User Mode, all incoming characters are echoed back to the user.

The user can wake the unit into User Mode by sending 3 <CR> (Enter Key) characters within 3 seconds. This prompt character “*” will be displayed when the unit is in Terminal Mode.

The unit will return to Computer Mode after 2 minutes of inactivity on the serial port. The Q command will return the unit immediately to Computer Mode.

Settings (must match computer settings):	
<ul style="list-style-type: none"> • Baud Rate = Selectable (see Section 5.2.4) • Parity = None • Stop Bits = 1 	
Command	Description
?,H	Displays the help menu
1	Returns the units settings information
2	Returns all available records from the data file
3	Returns all records since last '2' or '3' command.
4	Returns the last n records
D	Date (mm/dd/YY)
T	Time (HH:MM)
C	Clear data
S	Start a sample
E	End a sample
ST	Sample Time
RV	Show software revision.
ID	Set/Get the Location ID. Range 1-999.
FAx	Favorites alarm limit setting where x=1 or 2 for Alarm 1 or 2.
FSx	Favorites size setting where x=1 or 2 for Alarm Size 1 or 2 respectively.
SF	Favorites mode. 0=Off, 1=On
SH	Hold Time in seconds
SN	Sample Number of Samples (0=Repeat)
SR	Set Report Mode (0=None, 1=CSV, 2=Printer)
SS	Read serial number
CU	Count Units (0=CF, 1=/L, 2=TC, 3=M3)
TU	Temperature Units (0=C, 1=F)
RZ	Returns Channel Size information.
DT	Sets Date/Time without user interaction (string)
OP	Operational Status. S=Stop, R=Running, H=Hold.
CS	Set Channel Sizes (all 6 Channel Sizes)

8.2. Real Time Output

The real time output occurs when the unit finishes a sample. The output format is either a comma separated value (CSV) or a printer style depending on the Serial Report mode.

8.3. Comma Separated Value (CSV)

The CSV output fields are both comma separated and fixed length.

CSV Header (Note 1):

Time,Size1,Count1(M3),Size2,Count2(M3),Size3,Count3(M3),Size4,Count4(M3),Size5,Count5(M3),Size6,Count6(M3),AT(C),RH(%),Location,Seconds,Fav1Size,Fav2Size,Status

CSV Example Record:

2013-09-30

10:04:05,00.3,08562345,00.5,01867184,00.7,00654892,01.0,00245849,02.0,00055104,05.0,0031790,+023,040,001,010,00.3,00.5,000,*00086

CSV Fields			
Field	Parameter	Example Value	Notes
1	Date and Time	2013-09-30 10:04:05	
2	Channel 1 Size	0.3	
3	Channel 1 Count (TC, /L, CF, M3)	8562345	Note 2
4	Channel 2 Size	0.5	
5	Channel 2 Count (TC, /L, CF, M3)	1867184	Note 2
6	Channel 3 Size	0.7	
7	Channel 3 Count (TC, /L, CF, M3)	654892	Note 2
8	Channel 4 Size	1.0	
9	Channel 4 Count (TC, /L, CF, M3)	245849	Note 2
10	Channel 5 Size	2.0	
11	Channel 5 Count (TC, /L, CF, M3)	55104	Note 2
12	Channel 6 Size	5.0	
13	Channel 6 Count (TC, /L, CF, M3)	31790	Note 2
14	Temperature (C,F)	23	Note 2 & Note 3
15	RH (%)	40	Note 3
16	Location	1	
17	Sample Time (0-9999 seconds)	60	
18	Favorite 1 Size	0.3	Note 4
19	Favorite 2 Size	0.5	Note 4
20	Status Bits (see below)	0	Note 5

Status Bits		
Bit	Value	Condition
	0	OK (no alarms/errors)
0	1	Count alarm size 1
1	2	Count alarm size 2
2	4	Not used
3	8	Not used
4	16	Low battery
5	32	Sensor error
6	64	Not used
7	128	Not used

Notes (for table above):
1. CSV header included for multiple record transfers like All Data (2) or New Data (3). The CSV header does not print in Computer or Network mode.
2. Units determined by product setting.
3. Temperature and RH will be spaces (, ,) if Temp/RH probe is not attached.
4. Favorite sizes will be spaces (, ,) if alarms are disabled.
5. Status bit combinations are possible. For example, 17 (00010001B) = Low Battery and Size 1 alarm.

8.4. Printer Style

The printer output format is 9 lines by 26 characters (including T/RH if available).

8.5. RS485 Networking

The unit can be configured to operate in a Multi-Drop RS485 network using the Serial Out setting on the Settings Screen. The unit will also automatically be set to network mode if it detects network commands being sent to any device in the network.

When the unit is in network mode, it will not echo any characters or respond to any commands unless specifically addressed. The network address is the same as the Location ID set in the Sample Setup screen. It is important that no two units have the same Location ID set in the same network.

When in network mode, the unit is considered to be under Remote Control and key operating parameters cannot be changed by a local operator. These settings are: Sample Mode, Sample Time, Hold Time, Count Units and Temperature Units. The operator can still set the Serial Out to return the unit to Local Control. The Location can also be set to change the network address if necessary.

For additional information on networking commands and addressing refer to the BT-610-9801 Networking Supplement.

Figure 33 shows the RS485 connector location and pin assignments. Figure 34 shows a RS-485 network wiring diagram.

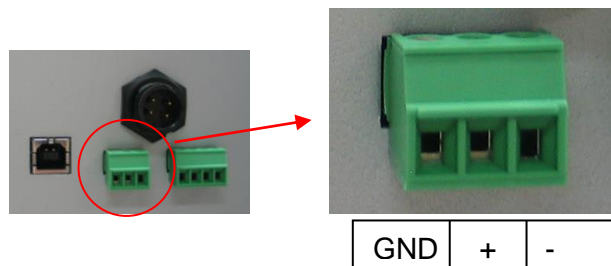

Figure 33 – RS485 Connector

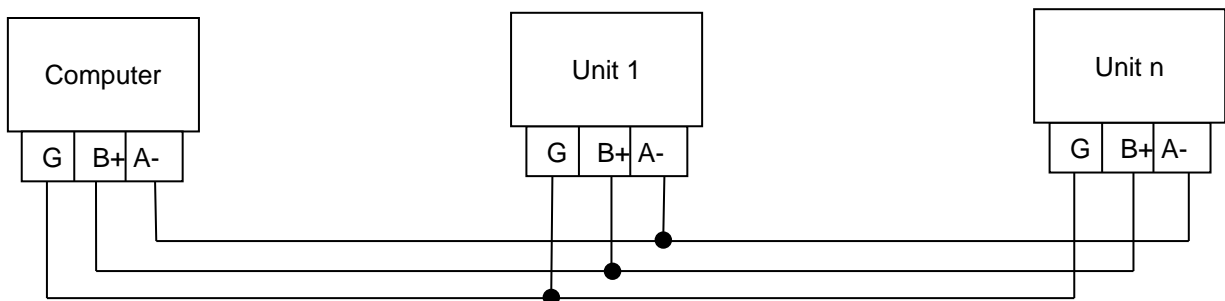

Figure 34 – RS485 Network

9. Maintenance

Due to the nature of the instrument, there are no customer serviceable components in the BT-610. The case of the BT-610 should never be removed or opened for any reason. **Opening or removing the case of the BT-610 voids the warranty and may result in exposure to laser radiation, which can cause eye injury.**

9.1. Service Schedule

Although there are no customer serviceable components in the BT-610, there are service items which ensure the proper operation of the instrument. Table 1 shows the service schedule for the BT-610.

Time Period	Item	Manual Section
Weekly	Zero Count Test	9.1.1
Monthly	Flow Rate Test	9.1.2
Yearly	Annual Calibration	9.1.3

Table 1 Service Schedule

9.1.1. Zero Count Test

Air leaks or debris in the particle sensor can cause false counts which may result in significant count errors when sampling clean environments. Perform the following zero count test weekly to ensure proper operation:

1. Attach the zero count filter to the inlet nozzle (P/N G3111).
2. Configure the unit as follows: Sample Mode = Single, Sample Time = 60 seconds, Volume = Total Count (TC)
3. Start and complete a sample.
4. The smallest particle size should have a count ≤ 1 .

9.1.2. Flow Rate Test

The flow rate test verifies the sample flow rate is within tolerance. The reference flow meter must be non-loading because the vacuum pump can be loaded down by external restrictions. Met One Instruments sells a suitable flow meter (P/N 9801). The flow rate test follows:

1. Connect a $\pm 3\%$ reference flow meter to the sample inlet nozzle.
2. Start a 5 minute sample.
3. The flow meter reading after ~ 3 minutes should be 0.1 CFM (2.831 LPM) $\pm 5\%$.
4. The flow rate can be adjusted using the front panel (see Section 5.7)

9.1.3. Annual Calibration

The BT-610 should be sent back to Met One Instruments yearly for calibration and inspection. The annual calibration cannot be performed by the customer because this calibration requires specialized equipment and a skilled technician. Met One Instruments maintains a calibration facility for calibrating particle counters according to industry accepted methods such as ISO and NIST. The annual calibration also includes inspection and preventative maintenance to improve product reliability.

9.2. Flash Upgrade

BT-610 is firmware upgradeable via the serial connection using a Met One Instruments flash burn program. Binary files and the flash program must be provided by Met One Instruments.

10. Troubleshooting

The following section covers some common failure symptoms, causes and solutions. It is important to note that there are no customer serviceable components in this product. The BT-610 case should never be removed or opened for any reason. **Opening or removing the case will void the warranty and may result in exposure to laser radiation, which can cause eye injury.**

Symptom	Possible Cause	Solution
Display does not turn on	<ul style="list-style-type: none">• Low Battery• Defective Battery	<ul style="list-style-type: none">• Charge battery• Send to service center
Pump does not turn on when a sample is started	<ul style="list-style-type: none">• Low Battery• Defective pump	<ul style="list-style-type: none">• Charge battery• Send to service center
Keypad does not work	<ul style="list-style-type: none">• Loose connector• Internal hardware failure	<ul style="list-style-type: none">• Send to service center
Printer does not print	<ul style="list-style-type: none">• Printer not enabled• Paper not installed• Paper not fed properly	<ul style="list-style-type: none">• Enable printer• Install paper• Open printer door, re-position paper
Sample result is lower than normal	<ul style="list-style-type: none">• Flow rate is low• Optics may be contaminated	<ul style="list-style-type: none">• Perform flow rate test• Send to service center
Sample result is higher than normal	<ul style="list-style-type: none">• Flow rate is high• Air leak in unit• Optics may be contaminated	<ul style="list-style-type: none">• Perform flow rate test• Send to service center• Send to service center
Battery does not hold a charge	<ul style="list-style-type: none">• Defective or worn out battery• Defective charger	<ul style="list-style-type: none">• Send to service center

11. Specifications

Performance

Particle Size Range	0.3µm - 10µm, 6 channels
Calibrated Sizes	0.3 µm, 0.5µm, 0.7µm, 1.0µm, 2.0µm 5.0µm and 10µm
User Size Settings	0.1µm steps from 0.3µm - 2.0µm 0.5µm steps from 2.0µm - 10µm
Concentration Range	0 – 3,000,000 particles per cubic foot (105,900 particle/L)
Accuracy	± 10% to calibration aerosol
Sensitivity	0.3 µm
Flow Rate	0.1 cfm (2.83 lpm)
Sample Time	Adjustable: 1 to 9999 seconds
Hold Time	Adjustable: 0 to 9999 seconds

Electrical

Light Source	Laser Diode, 90mW, 780 nm
Power	14.8V Li-Ion self-contained battery pack – Provides for 8 hours continuous use. Full recharge approximately 3 hours.
AC Adapter/Charger	AC to DC module, 100 – 240 VAC to 16.8 VDC @ 1.8 A
Printer	21 character per line thermal printer
Communications	USB, RS-232 or RS-485
Standards	Meets ISO 21501-4

Interface

Display	20 character x 4 line LCD
Keyboard	8 key membrane type

Physical

Height	8.55" (21.7 cm) With handle 10.05" (25.5 cm)
Width	6.8" (17.3 cm)
Depth	7.5" (19.1 cm)
Weight	8.25 lbs (3.7 kg)

Environmental

Operating Temperature	0° C to +50° C
Storage Temperature	-20° C to +60° C

Accessories

Supplied	Operation Manual	(P/N BT-610-9800)
	USB Cable	(P/N 500784)
	Comet Software	(P/N 82984)
	Particle View Software	Particle View
	Battery Charger	(P/N 80643)
	Iso-kinetic Sample Probe	(P/N G3110)
	Zero Particulate Filter	(P/N G3111)
	Printer Paper (2 Rolls)	(P/N 750514)
Optional	RH & Temperature Probe	(P/N G3120)
	Flow Meter	(P/N 9801)
	Serial Cable	(P/N 550065)

12. Warranty / Service

Warranty

Products manufactured by Met One Instruments, Inc. are warranted against defects and workmanship for a period of one (1) year from the ship date.

Any product found to be defective during the warranty period will, at the option of Met One Instruments, Inc., be replaced or repaired. In no case shall the liability of Met One Instruments, Inc. exceed the purchase price of the product.

This warranty may not apply to products that have been subject to misuse, negligence, accident, acts of nature, or that have been altered or modified other than by Met One Instruments, Inc. Consumable items such as filters, bearings pumps and batteries are not covered under this warranty.

Other than the warranty set forth herein, there shall be no other warranties, whether expressed, implied or statutory, including warranties of fitness of merchantability.

Service

Any product being returned to Met One Instruments, Inc. for service, repair or calibration, including items sent for warranty repair, must be assigned a return authorization (RA) number. Please call (541) 471-7111 or send an email to service@metone.com requesting an RA number and shipping instructions.

All returns must be shipped to the factory, freight pre-paid. Met One Instruments, Inc. will pay the shipping charge to return the product to the end user after repair or replacement of an item covered by warranty.

All instruments sent to the factory for repair or calibration must be free of contamination resulting from sampling chemicals, biological matter, or radioactive materials. Any items received with such contamination will be disposed and the customer will be billed a disposal fee.

Replacement parts or service/repair work performed by Met One Instruments, Inc. are warranted against defects in material and workmanship for a period of ninety (90) days from the date of shipment, under the same conditions as stated above.

REV 2013