

# twilight

INSTRUMENTOS DE MEDICIÓN INDUSTRIAL

## DR-TWIST PRO Manual

[www.twilight.mx](http://www.twilight.mx)

 / [twilightsadecv](#)

 / [twilightsadecv](#)

 / [twilightsadecv](#)



[www.twilight.mx](http://www.twilight.mx)



# *Dramiński Twist Grain pro*

Grain moisture meter  
with sample compressor

INSTRUCTION MANUAL **EN**

ISO 9001 | **CE**

# CONTENT

|            |  |    |
|------------|--|----|
|            | INTRODUCTION . . . . .   | 3  |
| CHAPTER 1  | EQUIPMENT . . . . .  | 5  |
| CHAPTER 2  | CONSTRUCTION OF THE DEVICE . . . . .                           | 7  |
| CHAPTER 3  | KEYBOARD FUNCTIONS . . . . .                                   | 11 |
| CHAPTER 4  | HOW TO START THE DEVICE . . . . .                              | 13 |
| CHAPTER 5  | NOTES FOR MEASUREMENTS . . . . .                               | 17 |
| CHAPTER 6  | HUMIDITY MEASUREMENTS . . . . .                                | 21 |
| CHAPTER 7  | EXTERNAL TEMPERATURE PROBE MEASUREMENTS . . . . .              | 25 |
| CHAPTER 8  | LIST OF AVAILABLE SPECIES AND HOW TO ADD NEW SPECIES . . . . . | 29 |
| CHAPTER 9  | UPDATE VIA USB . . . . .                                       | 31 |
| CHAPTER 10 | MODIFICATION OF HUMIDITY RESULTS . . . . .                     | 33 |
| CHAPTER 11 | MAIN MENU . . . . .  | 37 |
| CHAPTER 12 | CHANGE OF BATTERIES . . . . .                                  | 49 |
| CHAPTER 13 | FINAL NOTES . . . . .  | 53 |
| CHAPTER 14 | TECHNICAL DATA . . . . .                                       | 55 |



# INTRODUCTION

EN

Thank you for purchasing our new Dramiński Twist Grain pro grain moisture meter. This perfect product will be irreplaceable device in your activity. Due to its special design (and pressing the sample before the measurement), you will accurately determine your grain humidity.

Innovative solutions, state-of-the-art technology, vast versatility, USB connection and a possibility to connect an external temperature probe change the purchase of your TG pro into a priceless investment. We wish you fruitful harvests and pleasant work with the intelligent Draminski Twist Grain pro grain moisture meter.

The manufacturer DRAMINSKI S.A. is always ready to support their users with their knowledge and simultaneously reserves the right to introduce changes and improvements to the design and the software. DRAMINSKI S.A. also reserves the right to introduce changes to the present instruction manual.

Before using the device, please, read this instruction manual carefully. It will guarantee safety for the user and long, reliable functioning of the grain moisture meter.

Declaration of conformity is located at the head office of DRAMINSKI S.A., ul. Owocowa 17, 10-860 Olsztyn, Poland.

More information and current data you will find at **[www.draminski.com](http://www.draminski.com)**

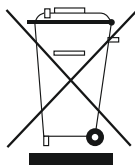

We would like to remind that electronic devices, batteries and accumulators cannot be thrown away into common domestic waste containers. The user is responsible to handover these types of waste to companies which deal with such utilization in accordance with the applicable legal provisions. By assuring proper utilization you help protect natural environment.

# EQUIPMENT

EN

## CHAPTER 1

## EQUIPMENT

1. Dрамиński Twist Grain Pro grain moisture meter,
2. Tightening cap of the measuring chamber (with inserted 3V battery type CR-2032),
3. Transport case,
4. Carrying strap attached to the case which enables hanging the device,
5. USB cable used to communicate with the computer,
6. Instruction manual,
7. 4 alkaline batteries 1.5V type LR6, AA,
8. Rubber protection of mini-USB slot.





# CONSTRUCTION OF THE DEVICE

EN

## CHAPTER 2

## EXTERNAL CONSTRUCTION

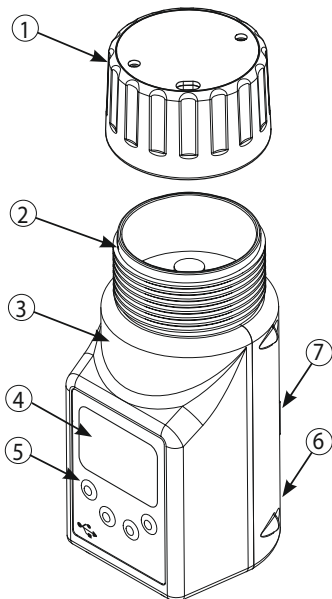

1. Tightening cap with a sound signaling a proper force of clamping,
2. Measuring chamber with a digital temperature sensor,
3. High quality ABS body,
4. LCD LED backlit graphic display,
5. Four-button membrane keyboard,
6. Mini-USB slot with a rubber protector,
7. Chamber for 4 batteries 1.5V type LR6, AA.

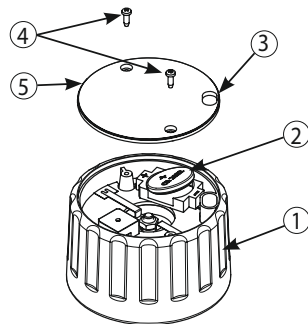

1. The cap's body is made with addition of fibreglass,
2. Battery 3V (type CR-2032) of the sound buzzer,
3. The slot to remove grain residuals,
4. Screws 2.5x10,
5. Lid of the cap.

## APPROXIMATE DIMENSIONS

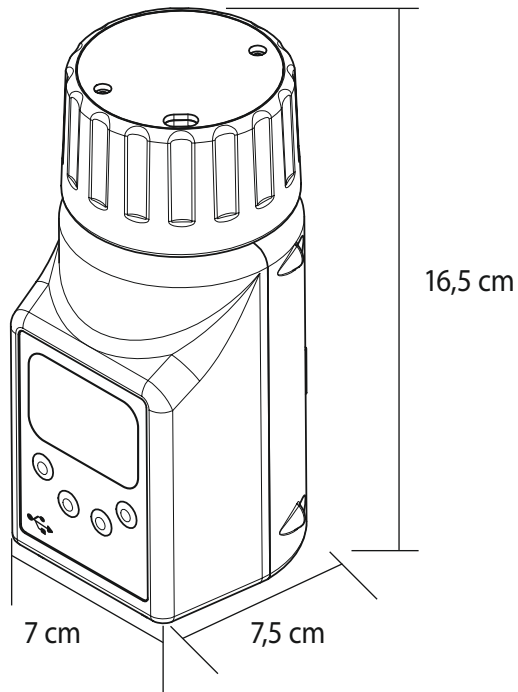







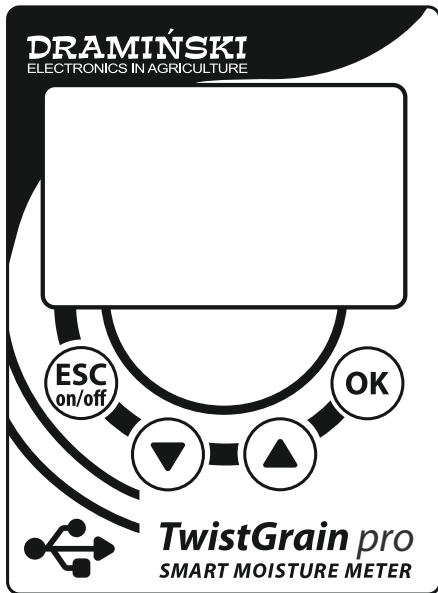

# KEYBOARD FUNCTIONS

EN

## CHAPTER 3



|   |   |
|---|---|
|  | <ul style="list-style-type: none"> <li>- To turn on the device.</li> <li>- To turn off the device, hold the button for 5 seconds, (NOTICE! TG pro can be turned off via the menu using "<b>Turn off!</b>", if the device is not operated, it will turn off automatically in order to save the battery).</li> <li>- To start the main menu – hold the button for 2 seconds.</li> <li>- To delete program functions.</li> </ul> |
|  | <ul style="list-style-type: none"> <li>- To confirm program function</li> <li>- To start measurement.</li> </ul>  |
|  | <ul style="list-style-type: none"> <li>- To navigate up and down the menu.</li> <li>- To set the values in the menu.</li> <li>- To select the grain from the list of species.</li> </ul>  |
|  | <ul style="list-style-type: none"> <li>- To clear the average result of the measurements of a particular sample.</li> </ul>   |
|  | <ul style="list-style-type: none"> <li>- To save the result with the date and hour to the memory of the device.</li> </ul>  |

# HOW TO START THE DEVICE

EN

## CHAPTER 4

The Twist Grain pro is ready to operate if the battery chamber contains properly inserted batteries (it is necessary to pay attention to polarity).

In the main menu of the device you can select the operating mode which you would like to use currently (basic or advanced).

In the basic mode we focus on easiness of the use and quick and comfortable measurements of humidity and temperature of the grain so that operating of the device was user-friendly for beginners.

In the advanced mode there are options enabling the usage of the external temperature probes, saving thousands of measurements to the internal memory of the device with dates and hours, segregation of the measurements taking into account the grain samples, place of storage, suppliers and much more information so that to satisfy the needs of the most demanding customers. Additionally, people who use the advanced mode can download special software from our site [www.draminski.com](http://www.draminski.com) to communicate with the computer which enables downloading the data from the TG pro to the computer hard disk, creating reports, prints, diagrams, spreadsheets etc

Turn ON the device using the  button.

a) a greeting message appears on the display which determines the name of the device, the software version, the version of calibration and the series number, for example:



b) then a list of available species appears on the display, in the upper corner appears a model of the device and current battery status (in the advanced mode there is also a date). After the device is turned on, there appears the latest tested species, for example:

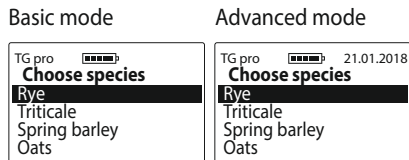



**NOTICE!** If the batteries are too low to carry on operating, the device automatically signals it with the following message:

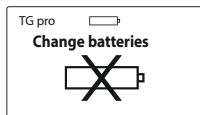

It means that the batteries have to be replaced by new ones.

c) in order to save the source of power supply, when the keys are not used, the devices turns to stand-by mode after a certain time, it means that the display turns black (this time can be set in the menu, see chapter: MAIN MENU). Pressing on any key causes that the device gets to operating mode again,

d) if the TG pro is in stand-by mode for a few minutes, it will be turned off automatically (this time can be set in the menu, see chapter: MAIN MENU). The device will signal this by turning on the display and there





appears a countdown from 10 to 0, which can be aborted by any button. However, if you do not do it, the device will turn off automatically in order to save the source of energy, for example:

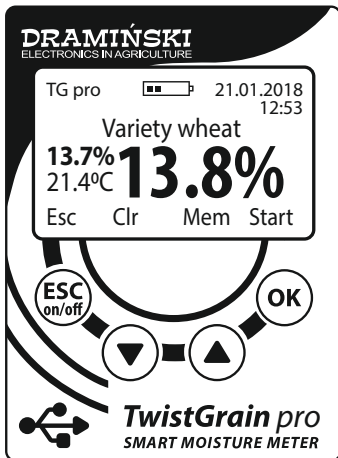

- e) in order to turn off the device, hold the  button for 5 seconds or from the position of the MAIN MENU choose option **"Turn off!"**
- f) during the measurements, in the lower part of the display you see the cues what a certain button of the membrane keyboard is responsible for, for example:

In the advanced mode



-  (function **Esc**) causes that you go back to the list of available species,
-  (function **Clr**) clears the average result,
-  (function **Mem**) safes the result in the internal memory,
-  (function **Start**) launches another measurement.

# NOTES FOR MEASUREMENTS

EN

## CHAPTER 5

- Before you start the measurements, it is necessary to check if the measuring chamber is clean and dry. It is important to remember to remove the grain from the chamber as soon as the measurement is finished.
- Fill the measuring chamber with the grain to the edge and then twist the tightening cap until you hear a sound signal. It is forbidden to add the grain after the sample has been pressed. In the case of some species (for example, grass seeds) which have an increased humidity, the cap may not produce the sound signal and in such a case it should be twisted to the end in order to perform the measurement (do not add any grain to the chamber).
- If the sound signal of the tightening cap is too weak, it is necessary to untwist the cap and replace the battery to a new one. It is forbidden to bend the plates which cause that the buzz produces a signal.
- During the measurements residual grain may penetrate to the screw of the cap. In order to make twisting the cap easier, you should regularly clean the screw, do not use any sharp tools for that purpose.
- Please, remember to clean the chamber carefully so that not to damage the temperature sensor which is located at the bottom of the measuring chamber.
- The water which is cumulated on the surface of the sample (for example, dew) can have an influence on the measurement results, that is why it is necessary to avoid those situations and before the measurement you need to "air" the sample.
- It is necessary to remember that the device has an automatic temperature compensation. That is why pay attention to the temperature of the measuring chamber, it should be similar to the temperature of the tested sample (the cold sample should not be tested in the device which has been exposed to the sun, and vice versa).
- The final result must be calculated from three measurements for the given sample (the average is calculated and displayed automatically). The number of meas-

urements from which the average is calculated can be changes in the main menu.

- To enable saving the measurement results to the memory of the device, it is necessary to run the advanced mode (additionally in the main menu of the device you can choose if the saved result must be the average of the measurements).
- In order to save the measurements from an external probe to the memory of the device, it is necessary to turn to the advanced mode and in the settings you should give this probe a name (it is important because it helps the results to be properly catalogued).
- If you notice some important deviations in the results for a certain species which increase or decrease the value in the whole measurement range in comparison to the laboratory method (drying and weighing method), it is recommended to modify the measurements (see CHAPTER: MODIFICATION OF HUMIDITY RESULTS).

- Every species has a different range of the measured humidity. However, its exceed is signaled by a proper sign, for example:

"<**8.5%**" (below the range), when the humidity of the tested sample is less than 8.5%,

">**35.0%**"(above the range), when the humidity of the tested sample is more than 35%.







# HUMIDITY MEASUREMENTS

EN

## CHAPTER 6

### In order to perform grain moisture measurements:

a) turn on the device with the help of  button, after a greeting message a list of available species appears (the TG pro displays the last tested grain species as soon as it is turned on),

b) with the help of  or  buttons, select (highlight) the name of the species which you are going to test and then confirm with the ,

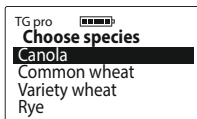

c) in accordance with the message, fill (to the edge) the measuring chamber with the tested grain,

d) fix the tightening cap on the thread of the measuring chamber until you hear a sound made by the cap. This sound means that the force of the tightening is correct. However, in order to save the battery of the cap you need to untwist it slightly until the signal disappears

(**NOTICE:** In the case of too soft grain the cap may not produce and sound. Then you need to twist it to the end of the thread, but never add any grain),

e) when the grain is properly pressed, start the measuring (function "**Start**") with the help of the  button. (**NOTICE:** When the display shows the message "**Analysing...**" do not touch the measuring chamber),

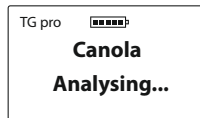

f) In a few seconds the display will show the moisture percent result (%) and the temperature of the sample (°C or °F depending on the user's settings),

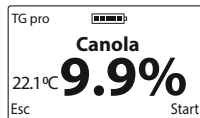



The moisture measurement result is presented taking into account the corrections connected with the temperature of the sample (automatic temperature compensation),

- g) when the measurement is finished, untwist the tightening cap and empty the measuring chamber. You need to do it carefully so that not to cause any mechanical damage to the temperature sensor which is at the bottom. Since the measuring chamber is empty, the device is ready for further operation. In order to perform measurements of another sample of the same species, fill the measuring chamber again and twist the cap properly. Then start the measurement with the **OK** button (or with the help of the **ESC** button go back to the list to select another species).

**NOTICE!** Proper cleaning of the measuring chamber is very important when you change the species of the sample and when you measure the samples with different and increased humidity,

- h) the final result of the moisture of the given sample is the average of, let's say, last three measurements.

The TG pro calculates it automatically and shows on the left side of the display (below the temperature result), for example:

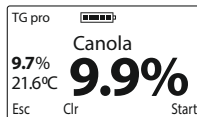

The number of measurements from which the average is calculated can be changed in the main menu. The results above and below the range are not taken into account when the average is calculated. If you want to calculate the average result from the beginning, you can clear it (function **Clr**) with the help of the **DOWN** button or go back to the list of the species with the help of the **ESC** button,

- i) The Twist Grain pro enables saving of 50 thousands of measurements to the internal memory of the device with the help of the **UP** button (function **Mem**). In order to use it, go to the main menu and change to "advanced" mode. Additionally, the user can choose if they want to save the current result of the average of the last measurements.

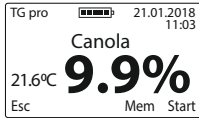

j) when you finish the measurements, in order to save the source of power supply, it is necessary to switch off the device holding the  button for 5 seconds or with the help of the option "**Turn off!**" available in the main menu.

# EXTERNAL TEMPERATURE PROBE MEASUREMENTS

EN

## CHAPTER **7**

The Dрамиński TwistGrain pro moisture meter can be used as a professional agricultural thermometer when you attach the external temperature probe to the mini-USB port. The TG pro is designed so that the user can purchase a probe of different construction without the necessity of calibration of the probe with the device. What is important is that every probe has its unique ID number. You can give it its own name and use the possibility of saving of thousands of measurements with the date and hour in the internal memory of the device. The TG pro automatically recognises the probes which have ever been connected and makes proper catalogues of the saved results.

The menu of the device enables management of the probes and the parameters of the device (adding new probes, renaming, deleting from the memory, clearing the results, changing the temperature scale °C/°F). In order to learn about all the functions, please, familiarise yourself with Chapter 11: MAIN MENU.

1. In order to use the temperature probe, change to advanced mode and connect the probe to the mini-USB port and start the option **"Temperature measurement"** in the Main menu. The probes which have not been added to the memory under their own name are recognised as **"No name"** by the device.



2. In order to save the results, the probe should be added to the memory of the device (see CHAPTER 11: MAIN MENU) When the probe is saved, the device recognises it automatically and displays its name, for example: **"PROBE NO 1"** At this moment using the  button (function **Mem**) we can save thousands of the results to the memory with the date and hour so that to transfer these data to the computer and store, create reports, spreadsheets, graphs of changes in the function of the time or generate the prints.

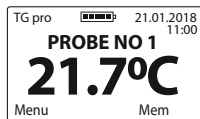

Special software for data transition is available at the site [www.draminski.com](http://www.draminski.com), bookmark **Products / Moisture meters / Draminski TwistGrain pro.**



# LIST OF AVAILABLE SPECIES AND HOW TO ADD NEW SPECIES

EN

## CHAPTER 8

The Draminski TG pro moisture meter is able to save some hundreds of different sorts of grain in its memory which the user can use when performing the measurements. The list of the available species may be different depending on the current commercial offer, promotion or the country where the TG pro was purchased.

Always updated list of all available species can be found at **www.draminski.com** in the bookmark **Products / Moisture meters / Draminski TwistGrain pro**.

Every Draminski TG pro user can activate additional species by entering their code in the main menu using the option **"Add species"** (see CHAPTER: MAIN MENU). In order to obtain this special code activating the species which you need in your TG pro, please, contact us:

**e-mail: [agri@draminski.com](mailto:agri@draminski.com)**

**phone: +48 89 527 11 30**

or the nearest certified distributor of Draminski S.A.

Contact us if you have species which have not been developer yet or a special grain variety which you would like to examine, because mutually we can create new species in order to satisfy your needs. These species can also be added into your device using a special code.

Thanks to these modern solutions the TG pro has become a versatile moisture meter which will always be up-to-date and will have unlimited possibilities.



# UPDATE VIA USB

EN

## CHAPTER 9

The Draminski TG pro has a mini-USB port which gives fast and comfortable way for the user to update the data in the memory of their device, the software, the list of language versions, update new functions in the device and many other things.

Check update availability at **www.draminski.com** in the bookmark **Products / Moisture meters / Draminski TwistGrain pro**.

You will also find there step-by-step instructions how to process the update.

Our software developers did their best to make updating easy and user-friendly so that even those users who have little computer technology knowledge would not have any problems with that.

If you have any questions or doubts, please, contact your specialists.

**e-mail: [agri@draminski.com](mailto:agri@draminski.com)**

**phone: +48 89 527 11 30**

# MODIFICATION OF HUMIDITY RESULTS

EN

## CHAPTER 10

The Dramiński TG Pro has humidity curves saved in its memory. They were developed on the basis of normalized samples (their density was determined and the mass of 1000 grains). Thanks to them the results are accurate and repeatable. However, it might happen that in a certain year (due to different factors), the user's harvest is slightly different from the normalized grain and then deviations in humidity results may occur.

These factors are as follows:

1. Shape of the grain and its ripeness (plumpness),
2. Variety qualities of the grain,
3. Level of contamination and tailings,
4. Level of devastation of the grain by pests and fungi.

### NOTICE!

Please, remember to compare the measurements only to laboratory drying and weighing method but not to other moisture meters because they may mislead you.

The Draminski TG pro moisture meter enables introduction of modification of the measurements autonomously. When modification is carried out, each species is treated separately. When modification has been carried out, the sign "\*" (asterisk) appears next to the species. During the measurements below the name of the tested species there appears information about the value of modification (the result automatically takes into consideration the introduced modification), for example:

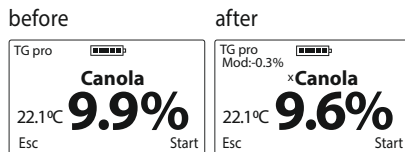

It is recommended to reset the default settings and if necessary introduce new modification again. When you reset the default settings, the "\*" (asterisk) will disappear.

**A detailed description how to carry out modification of humidity results and how to reset default settings you will find in Chapter: MAIN MENU.**



# MAIN MENU





EN

## CHAPTER 11

Using the functions of the main menu the user can turn off the device quickly, adjust operating settings to their needs, add new species, manager the memory and do many other things.

**To start MAIN MENU hold the button  for 2 seconds.**



### 1. Turn off!

To turn off the device, enter the **MAIN MENU** with the help of the  button then with the help of  or  select the option **Turn off!** and confirm with the  button.



Thanks to this function the user can turn off the device quickly without the necessity of holding the  button for 5 seconds.



### 2. Species list

In order to return from the **MAIN MENU** to the list of species, use the  button or with the help of the arrows select the **Species list** and confirm with the  button.



### 3. Operating mode



a) **Basic** – in order to make operation of the device easy and use only basic functions of the menu, enter the **Main menu / Operating mode** then with the help of  or  select the option **Basic** and confirm with , for example:



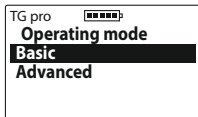

- b) **Advanced** – in order to use all the options of the device such as real-time clock, saving the measurements, operating the temperature probe, etc, enter **Main menu / Operating mode**, then using  $\downarrow$  or  $\uparrow$  select the option **Advanced** and confirm with  $\text{OK}$ , for example:

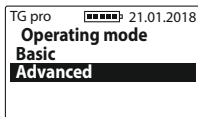

#### 4. Temperature measurement

In order to use the external temperature probe, connect it to the TG pro via mini-USB port, enter the **Main menu**, then navigate  $\downarrow$  or  $\uparrow$  and choose the option **Temperature measurement** and confirm with  $\text{OK}$  button.

**NOTICE:** In order to save the results to the memory of the device, add the probe in the settings of the main menu and name it.



#### 5. Settings



##### 5.1 Language

In order to change a language version of the device, enter the **Main menu / Settings / Language**, then choose the language version with the help of  $\downarrow$  or  $\uparrow$  and confirm with the  $\text{OK}$  button, for example:

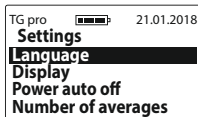

## 5.2 Display

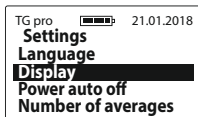

5.2 a) **Backlight intensity** – energy saving LED backlight is used in the device. However, you need to remember that stronger backlight consumes more electric power which discharges the battery quicker. In order to decrease backlight intensity, enter the **Main menu / Settings / Display / Backlight intensity**, then select a proper value with the help of (⏴) or (⏵) and confirm with the (OK) button, for example:

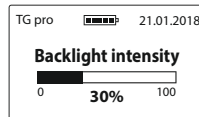

5.2 b) **Backlight off time** – regulation of time after which the display backlight turns off and the device turns to the stand-by mode waiting until the keyboard is used (this time is calculating from the moment the keyboard was used for the last time). In order to change the backlight off time, enter the **Main menu / Settings / Display / Backlight off time**, then navigate with (⏴) or (⏵) to select the proper time and and confirm with (OK), for example:

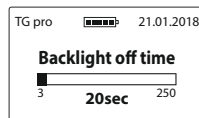

5.2 c) **LCD contrast** – in order to change the LCD contrast, enter the **Main menu / Settings/ Display / LCD contrast**, then choose an appropriate value with the help of  $\downarrow$  or  $\uparrow$  and confirm with  $\text{OK}$ , for example

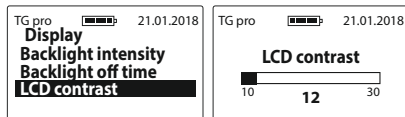

### 5.3 Power auto off

Regulation of time after which the device turns off automatically counts down from the moment when the keyboard was touched for the last time. In order to change the power auto off, enter the **Main menu / Settings / Power auto off**, then choose an appropriate value with the help of  $\downarrow$  or  $\uparrow$  and confirm with  $\text{OK}$ , for example:

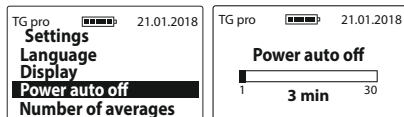

### 5.4 Number of averages

The device automatically calculates the average of the last measurements. In order to set the number of measurements from which the average is calculated, enter the **Main menu / Settings / Number of averages**, then choose an appropriate number with the help of  $\downarrow$  or  $\uparrow$  and confirm with  $\text{OK}$ , for example:

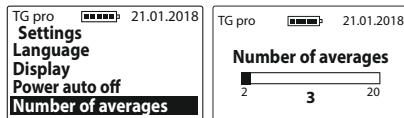

The average results appears on the left side of the display (above the temperature value) after three measurements have been performed if the number of averages is set to "3", for example:

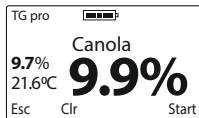

**Notice!** In order to calculate the average result from the beginning, you can clear it. Select the function (function **Clr**) with the help of and a message appears: **“Clear average?”** then confirm with the button or delete with them button (the average will also be cleared if you return to the list and select the species).

## 5.5 Temperature scale

In order to change the temperature scale from Celsius to Fahrenheit or vice versa, enter the **Main menu / Settings / Temperature scale**, then select a proper scale with the help of or and confirm with the button, for example:





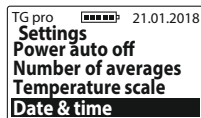

## 5.6 Date & time

The TG pro has a real time clock thanks to which the results are saved to the memory with the current date and time of the test.

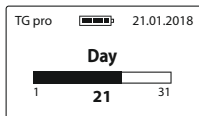
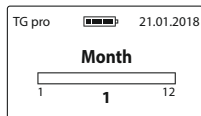



5.6 a) **Set date** – in order to set current time, enter the **Main menu / Settings / Date & time / Set date**, then with the help of or select proper value and confirm accordingly: year / month / date, for example:



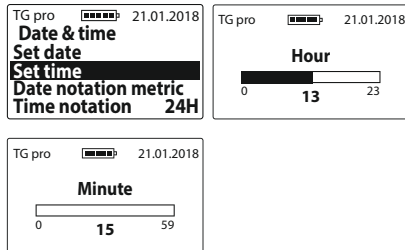

5.6 b) **Set time** – in order to set time, enter the **Main menu / Settings / Date & time / Set time**, then with the help of  or  select the proper value and confirm accordingly hour / minute with , for example:

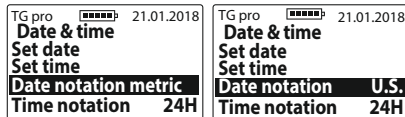

5.6 c) **Date notation** – in order to change date notation, enter the **Main menu / Settings / Date & time**, with the help of  or  choose the option **Date notation**, and then change into **metrical** (day, month, year) or **imperial** (month, day, year) and confirm with the  button for example:



5.6 d) **Time notation** – in order to change time notation, enter the **Main menu / Settings / Date & time**, with the help of  or  choose the option Time notation, then using the  button change from **24H** to **12H**, for example

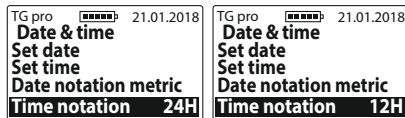

## 5.7 Temperature probes

This option enables adding external temperature probes to the memory so that to be able to save the measurements to a certain catalogue, change names of the previously added probes or delete them permanently with their catalogue measurements.

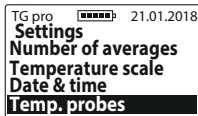

5.7 a) **Add probe** – in order to add a probe and create a catalogue for measurements, connect the probe to the mini-USB port, enter the **Main menu / Settings / Temperature probes / Add probe**, enter its name (navigate with arrows and confirm the highlighted signs with the **OK** button), when the name is ready, use the **ESC** button, then the message appears: “**Save name?**”, which should be accepted with the **OK** button or rejected with the **ESC** button, for example:

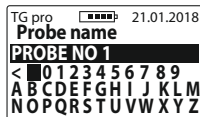
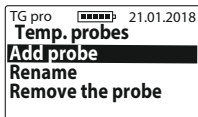

5.7 b) **Rename** – in order to rename previously saved probe, enter the **Main menu / Settings / Temperature probes / Rename**, select the name you would like to change with the arrows and accept with the **OK** button, enter a new name for this probe (change with the help of the arrows and confirm the highlighted signs with the **OK** button). When the name is ready, use **ESC**, then a message appears: “**Save name?**”, which should be accepted with the **OK** button or rejected with the **ESC** button.

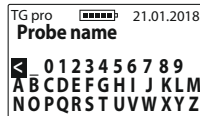
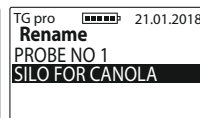
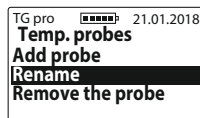

5.7 c) **Remove the probe** – in order to remove the probe with its measurements, enter the **Main menu / Settings / Temperature probes / Remove the probe**,

select the name of the probe you would like to remove with the help of the arrows and confirm with **(OK)**, then a message appears **"Remove?"**, which should be accepted with **(OK)**, or rejected with **(ESC on/off)**.

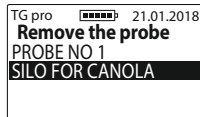

## 5.8 Memory



5.8 a) **Save** – in order to change the way of saving the measurements, enter the **Main menu / Settings / Memory**, with the help of **(↓)** or **(↑)** select the option **Save**, then using the **(OK)** buttons change to **results** or **average**, for example:



5.8 b) **Delete humidity results** – in order to delete all of the saved humidity results of the grain, enter the **Main menu / Settings / Memory**, with the help of **(↓)** or **(↑)** select the option **Delete humidity results** and confirm with **(OK)**.



5.8 c) **Delete temperature results** – in order to delete all the temperature results from the external probes, enter the **Main menu / Settings / Memory**, then with the help of **(↓)** or **(↑)** select the option **Delete temperature results** and confirm with **(OK)**.



5.8 d) **Available memory** – in order to check memory availability, enter the **Main menu / Settings/ Memory**, with the help of  $\downarrow$  or  $\uparrow$  select the option **Available memory** and confirm with the  $\text{OK}$  button, for example:

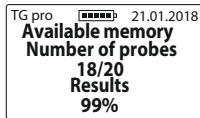

## 6. Result modification

Before entering any modification (correction) of the results, it is necessary to read **CHAPTER: MODIFICATION OF HUMIDITY RESULTS**

In order to insert modifications for the species, enter the **Main menu / Result modification**, with the help of  $\downarrow$  or  $\uparrow$  select the species you would like to modify, then

select the value by which you would like to increase or decrease the humidity value and confirm with the  $\text{OK}$  button, for example:

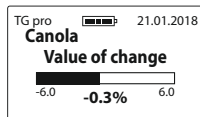

When the modifications have been made, at the name of the species there appears "\*" (asterisk) informing by which value the default settings have been modified, for example:

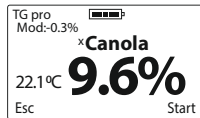
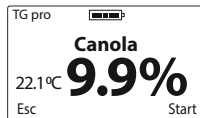



In order to return to the default settings, set to "0,0%", then the asterisk next to the name of the species also disappears, for example:

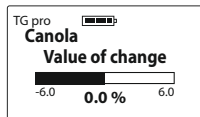

## 7. Add species

First read CHAPTER: LIST OF AVAILABLE SPECIES AND HOW TO ADD NEW SPECIES.

In order to add new species to the TG pro grain moisture meter, enter the **Main menu** with the help of  $\downarrow$  or  $\uparrow$  and then select the option **Add species** and confirm with  $\text{OK}$ , for example:

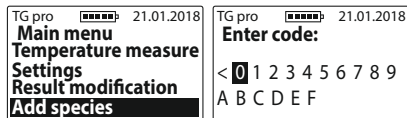

In order to enter the special code, select proper signs with the help of  $\downarrow$  or  $\uparrow$  and confirm with  $\text{OK}$  (in order to delete the sign, use the symbol "<" and confirm with  $\text{OK}$ ). When you have entered the code, a message appears: "**Accept code?**", which should be confirmed with  $\text{OK}$ , or example:

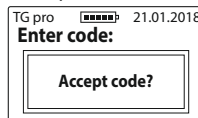

**Notice!** Entering the same code enables adding and deleting the species (alternately) in the available list of the device. The codes are for this particular device, thus if you would like to activate new species in two TG pro moisture meters, you would need two different codes.

## 8. About

In order to check information about the device and contact details of the manufacturer, enter the **Main menu** with the help of  $\text{ESC}_{\text{on/off}}$ , then use the buttons  $\downarrow$  or  $\uparrow$  and choose the option **About** and confirm with  $\text{OK}$  button.

Here you can check the model of the device, its firmware, series number and on the second page the address and contact details of the Draminski S.A. company.



# CHANGE OF BATTERIES

EN

## CHAPTER 12

UThe device automatically signals when the batteries are low. In such a situation immediately after the device has been switched on or when it is being operated, a message appears "**Change batteries**" in graphic form and then the TG pro turns off automatically.

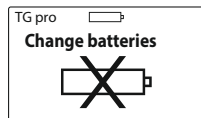

The moisture meter is powered by four 1.5 V type LR6, AA batteries.

### In order to change the batteries:

- open the cover of the battery compartment with the help of the ribbon tip,
- place the ribbon across inside of the battery compartment, so that its tip comes beyond the cover,
- insert new batteries in accordance with their polarity +/- (pressing the ribbon inside),
- put the cover again. When you hear a click, it means that

the security device is properly locked and there is no risk that the batteries fall out.

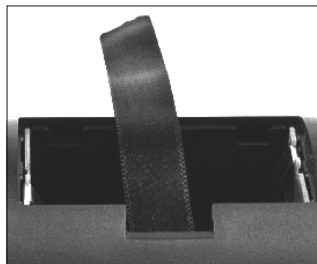

### **Change of batteries in the tightening cap with a buzzer.**

One battery 3V (type CR-2032) powers the buzzer in the tightening but of the measurement chamber. When the sound becomes weak or disappears, it is necessary to change the battery.

#### **To change the battery you should:**

- unscrew two screws which are in the cap,
- lift the lid and delicately lever the battery from the base,
- insert a new battery in accordance with polarity +/-,
- put the lid of the tightening cap again and screw it with two screw (2.5x10).

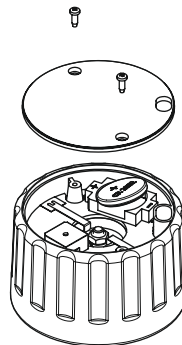



# FINAL NOTES

EN

## CHAPTER 13

- The grain moisture meter should be protected against direct impact of water. Avoid using it in alternately extreme temperatures. You cannot allow water vapour condense on the metal parts of the device because it might have an influence on the measurement results.
- At the end of a season, when you finish working with the device, you need to clean and dry the measuring chamber and the tightening cap properly. The device must be kept in a dry and warm room. Proper maintenance and storage conditions guarantee long life and reliability of the device.
- If you are not going to use the device for a longer time, it is recommended to take out the batteries from the battery compartment in order to limit the risk of damage of the device due to leakage of the electrolyte. **It is recommended to use batteries of recognised manufacturers.**
- If any problems appear with the device or when interpreting the results, it is recommended (before sending the device to the service) to contact the manufacturer, that is DRAMINSKI S.A. or the nearest authorized distributor. This contact is important especially before sending the device to the warranty servicing because most of the problems can be solved remotely. However, when you send properly operating device groundlessly, you will be charged with costs of maintenance and shipment.
- It is forbidden to dismantle the device, to interfere or maintain it by unauthorized people, because it might cause permanent damage and it will invalidate the warranty.
- Pay attention to the rubber shield of the mini-USB slot, because when it is missing, the slot is exposed to dirt.



# TECHNICAL DATA

EN

## CHAPTER 14

|  |   |
|--|---|
| <b>Dimensions</b>  | 16.5 × 7.0 × 7.5 cm   |
| <b>Weight of the device</b>  | 520 g (with batteries and the tightening cap)   |
| <b>Way of filling the chamber</b>                                  | manual  |
| <b>Method of humidity measurement</b>                              | impedance in 4 frequencies  |
| <b>Sample's capacity</b>   | 90 ml   |
| <b>Measurement control</b>   | single system microcomputer   |
| <b>Power supply</b>  | 4 batteries 1.5V type AA + 1 battery 3V type CR-2032  |
| <b>Power intake</b>  | from 30 to 72 mA w depending on the user's settings   |
| <b>Approximate time of continuous operation on one battery set</b> | 77 hours when backlight is set to 0%<br>54 hours when backlight is set to 30%   |
| <b>Low battery indicator</b>                                       | graphic   |
| <b>Measurement resolution</b>                                      | humidity – 0.1%, temperature – 0.1°C/°F   |
| <b>Humidity measurement accuracy</b>                               | ± 0.5 % for normalized grain<br>± 1 % in the range up to 10 % of humidity<br>± 1.5 % in the range over 10 % of humidity and can increase if the sample's humidity increases |
| <b>Temperature measurement accuracy</b>                            | ± 0.5°C in the range from 0°C to 85°C / ± 0.9°F in the range from 32°F to 185°F   |
| <b>Temperature measurement range</b>                               | from 0°C to 125°C   |
| <b>Correction of measurements</b>                                  | using the keyboard – option “modification”  |
| <b>Save data</b>   | internal storage  |
| <b>Internal memory capacity</b>                                    | – 50000 measurements with date and time<br>– 20 external temperature probes recognised automatically on the basis of ID number<br>– 20 language versions<br>– 400 species   |

|  |  |
|--|--|
| <b>Checking the memory status</b>        | from menu  |
| <b>External temperature probe</b>        | with a digital temperature sensor connected to mini-USB port   |
| <b>Display</b>                           | graphic LCD LED backlit, diagonal 2"   |
| <b>Keyboard</b>                          | membrane   |
| <b>Temperature compensation</b>          | considered automatically   |
| <b>Additional functions</b>              | <ul style="list-style-type: none"> <li>real time clock,</li> <li>save measurements to the memory (date, time and sample number),</li> <li>data transmission to PC,</li> <li>preview of memory status,</li> <li>preview of battery status,</li> <li>temperature measurement with an external probe,</li> <li>change of operating mode (basic/advanced),</li> <li>modification of humidity results,</li> <li>adding new species using special codes,</li> <li>calculation of the average result,</li> <li>automatic temperature compensation,</li> <li>pop-up menu,</li> <li>setting the display parameters,</li> <li>selecting a language version,</li> <li>selecting the temperature scale,</li> <li>change of power auto off time, update of data and software,</li> <li>special software to manage the data saved on PC<br/>(generation of reports, spreadsheets, diagrams, prints)</li> </ul> |
| <b>Recommended operating temperature</b> | from 10°C to 35°C  |
| <b>Recommended storage temperature</b>   | from 5°C to 45°C   |

# twilight

INSTRUMENTOS DE MEDICIÓN INDUSTRIAL



LLÁMANOS

+52(81) 8115-1400 / +52 (81) 8173-4300

LADA Sin Costo:  
01 800 087 43 75

E-mail:  
[ventas@twilight.mx](mailto:ventas@twilight.mx)

[www.twilight.mx](http://www.twilight.mx)



/ [twightsadecv](https://www.facebook.com/twightsadecv)



/ [twightsadecv](https://twitter.com/twightsadecv)



/ [twightsadecv](https://www.youtube.com/twightsadecv)