

# **116**

## True-rms Multimeter

## Users Manual

July 2006 Rev. 2, 5/21

© 2006-2021 Fluke Corporation. All rights reserved.

Specifications are subject to change without notice.

All product names are trademarks of their respective companies.

## LIMITED WARRANTY AND LIMITATION OF LIABILITY

Each Fluke product is warranted to be free from defects in material and workmanship under normal use and service. The warranty period is three years and begins on the date of shipment. Parts, product repairs, and services are warranted for 90 days. This warranty extends only to the original buyer or end-user customer of a Fluke authorized reseller, and does not apply to fuses, disposable batteries, or to any product which, in Fluke's opinion, has been misused, altered, neglected, contaminated, or damaged by accident or abnormal conditions of operation or handling. Fluke warrants that software will operate substantially in accordance with its functional specifications for 90 days and that it has been properly recorded on non-defective media. Fluke does not warrant that software will be error free or operate without interruption.

Fluke authorized resellers shall extend this warranty on new and unused products to end-user customers only but have no authority to extend a greater or different warranty on behalf of Fluke. Warranty support is available only if product is purchased through a Fluke authorized sales outlet or Buyer has paid the applicable international price. Fluke reserves the right to invoice Buyer for importation costs of repair/replacement parts when product purchased in one country is submitted for repair in another country.

Fluke's warranty obligation is limited, at Fluke's option, to refund of the purchase price, free of charge repair, or replacement of a defective product which is returned to a Fluke authorized service center within the warranty period.

To obtain warranty service, contact your nearest Fluke authorized service center to obtain return authorization information, then send the product to that service center, with a description of the difficulty, postage and insurance prepaid (FOB Destination). Fluke assumes no risk for damage in transit. Following warranty repair, the product will be returned to Buyer, transportation prepaid (FOB Destination). If Fluke determines that failure was caused by neglect, misuse, contamination, alteration, accident, or abnormal condition of operation or handling, including overvoltage failures caused by use outside the product's specified rating, or normal wear and tear of mechanical components, Fluke will provide an estimate of repair costs and obtain authorization before commencing the work. Following repair, the product will be returned to the Buyer transportation prepaid and the Buyer will be billed for the repair and return transportation charges (FOB Shipping Point).

THIS WARRANTY IS BUYER'S SOLE AND EXCLUSIVE REMEDY AND IS IN LIEU OF ALL OTHER WARRANTIES, EXPRESS OR IMPLIED, INCLUDING BUT NOT LIMITED TO ANY IMPLIED WARRANTY OF MERCHANTABILITY OR FITNESS FOR A PARTICULAR PURPOSE. FLUKE SHALL NOT BE LIABLE FOR ANY SPECIAL, INDIRECT, INCIDENTAL OR CONSEQUENTIAL DAMAGES OR LOSSES, INCLUDING LOSS OF DATA, ARISING FROM ANY CAUSE OR THEORY.

Since some countries or states do not allow limitation of the term of an implied warranty, or exclusion or limitation of incidental or consequential damages, the limitations and exclusions of this warranty may not apply to every buyer. If any provision of this Warranty is held invalid or unenforceable by a court or other decision-maker of competent jurisdiction, such holding will not affect the validity or enforceability of any other provision.

Fluke Corporation  
P.O. Box 9090  
Everett, WA 98206-9090  
U.S.A.

Fluke Europe B.V.  
P.O. Box 1186  
5602 BD Eindhoven  
The Netherlands

# Table of Contents

Title	Page
Introduction .....	1
Contact Fluke .....	1
Safety Information .....	1
Unsafe Voltage.....	1
Display .....	2
Terminals .....	3
Error Messages.....	3
Rotary Switch Positions .....	4
Battery Saver™ (Sleep Mode) .....	4
MIN MAX AVG Recording Mode.....	5
Display HOLD .....	5
Backlight.....	5
Manual and Autoranging .....	6
Power-Up Options.....	6
Making Basic Measurements .....	7
Measuring Resistance .....	7
Testing for Continuity.....	7
Measuring AC and DC Voltage.....	8
Using Auto Volts Selection .....	8
Measuring AC and DC Millivolts .....	8
Measuring AC or DC Current.....	9
Measuring Capacitance .....	10
Measuring Temperature .....	10
Measuring Frequency .....	11
Making Low Impedance Capacitance Measurements .....	11
Testing Diodes.....	12
Measuring Current above 600 $\mu$ A.....	13
Using the Bargraph.....	13
Maintenance.....	14
Replacing the Battery .....	14
Cleaning .....	14
Specifications .....	15



## Introduction

The Fluke Model 116, is a battery-powered, true-rms multimeter (the Meter or Product) with a 6000-count display and a bar graph.

## Contact Fluke

Fluke Corporation operates worldwide. For local contact information, go to our website: [www.fluke.com](http://www.fluke.com)

To register your product, view, print, or download the latest manual or manual supplement, go to our website.

Fluke Corporation  
P.O. Box 9090  
Everett, WA 98206-9090

+1-425-446-5500

[fluke-info@fluke.com](mailto:fluke-info@fluke.com)

## Safety Information

General Safety Information is in the printed Safety Information document that ships with the Product and at [www.fluke.com](http://www.fluke.com). More specific safety information is listed where applicable.

A **Warning** identifies hazardous conditions and procedures that are dangerous to the user. A **Caution** identifies conditions and procedures that can cause damage to the Product or the equipment under test.

## Unsafe Voltage

To alert you to the presence of a potentially hazardous voltage, the ⚡ symbol shows when the Meter measures a voltage  $\geq 30$  V or a voltage overload (**OL**) condition. When making frequency measurements  $> 1$  kHz, the ⚡ symbol is unspecified.

## Display

Table 1 shows the areas of the display.

Table 1. Display

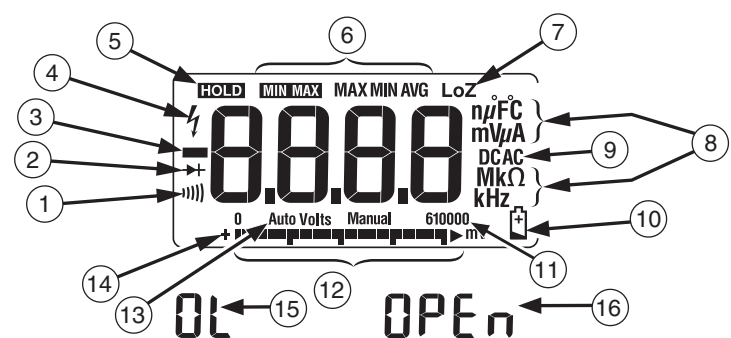

Item	Symbol	Description
①		The Meter function is set to Continuity.
②	→	The Meter function is set to Diode Test
③	-	Input is a negative value.
④	⚡	⚠ Unsafe voltage. Measured input voltage $\geq 30$ V, or voltage overload condition (OL).
⑤	<b>HOLD</b>	Display hold enabled. Display freezes present reading.
⑥	<b>MIN MAX</b> <b>MAX MIN</b> <b>AVG</b>	MIN MAX AVG mode enabled. Maximum, minimum, average or present reading displays
⑦	<b>LoZ</b>	The Meter is measuring voltage or capacitance with a low input impedance.
⑧	$\mu\text{F}$ $\text{mV}$ $\mu\text{A}$ $\text{Mk}\Omega$ $\text{kHz}$	Measurement units.
⑨	<b>DC AC</b>	Direct current or alternating current
⑩	🔋	Battery low warning.
⑪	<b>610000 mV</b>	Indicates the Meter's range selection.
⑫	(Bar graph)	Analog display.
⑬	<b>Auto Volts</b>	The Meter is in the Auto Volts function.
	<b>Auto</b>	Autoranging. The Meter selects the range for best resolution.
	<b>Manual</b>	Manual ranging. User sets the Meter's range.
⑭	<b>+</b>	Bar graph polarity
⑮	OL	⚠ The input is too large for the selected range.
⑯	OPEN	Thermocouple missing or defective when Temperature function is selected.

## Terminals

Table 2 is a list of terminals on the Meter.

**Table 2. Terminals**

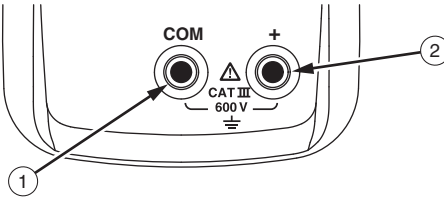
	
No.	Description
①	Common (return) terminal for all measurements.
②	Input terminal for all measurements.

## Error Messages

Table 3 is a list of error messages for the Meter.





**Table 3. Error Messages**

Error Messages	
bAtt	Battery must be replaced before the Meter will operate.
Cal Err	Calibration required. Meter calibration is required before the Meter will operate.
EEP Err	Internal error. The Meter must be repaired before it will operate.
Fll Err	Internal error. The Meter must be repaired before it will operate.

## Rotary Switch Positions

Table 4 is a list of the rotary switch positions and features.

Table 4. Features

Switch Position	Measurement Function
OFF	The Meter is turned off.
AUTO-V LoZ	Automatically selects ac or dc volts based on the sensed input with a low impedance input.
$\tilde{V}^{Hz}$	AC voltage from 0.06 V to 600 V. Frequency from 5 Hz to 100 kHz.
$\bar{V}$	DC voltage from 0.001 V to 600 V.
$\tilde{mV}^{DC}$	AC voltage from 6.0 to 600 mV, dc-coupled. DC voltage from 0.1 to 600 mV.
$\Omega$	Ohms from 0.1 $\Omega$ to 40 M $\Omega$ .
	Temperature from -40 °C to 400 °C (-40 °F to 752 °F) with K-type thermocouple
	Continuity beeper turns on at <20 $\Omega$ and turns off at >250 $\Omega$ .
	Diode Test. Displays <b>OL</b> above 2.0 V.
	Farads from 1 nF to 9999 $\mu$ F.
$\bar{\mu A}^{\tilde{}}$	DC current from 0.1 to 600 $\mu$ A. AC current from 6.0 to 600 $\mu$ A. DC-coupled.
<i>Note: All ac functions and Auto-V LoZ are true-rms. AC voltage is ac-coupled. Auto-V LoZ, AC mV and AC amps are dc-coupled.</i>	

## Battery Saver™ (Sleep Mode)

If the Meter is ON, but inactive and not connected to voltage for more than 20 minutes, the display goes blank to save battery life. To use the Meter, press any button or turn the rotary switch. To disable the Sleep mode, see [Power-Up Options](#). The Sleep mode is always disabled in the MIN MAX AVG mode.



## MIN MAX AVG Recording Mode

The MIN MAX AVG recording mode captures the minimum and maximum input values (ignoring overloads), and calculates a running average of all readings. When the Meter detects a new high or low, the Meter beeps.

### Note

*Autoranging and Battery Saver™ are disabled in MIN MAX AVG mode.*

To set up:

1. Select the measurement function and range.
2. Push **MIN MAX** to enter MIN MAX AVG mode.
3. **MIN MAX** and MAX show on the display. The highest reading detected since entering MIN MAX AVG shows on the display.
4. Push **MIN MAX** to step through the low (MIN), average (AVG), and present readings.
5. To pause MIN MAX AVG recording without erasing stored values, push **HOLD**. (**HOLD** shows on the display.)
6. To resume MIN MAX AVG recording, push **HOLD** again.
7. To exit and erase stored readings, push **MIN MAX** for at least one second, or turn the rotary switch.

## Display HOLD

### Warning

**To avoid electric shock, when Display HOLD is activated, be aware that the display will not change when you apply a different voltage.**

In the Display HOLD mode, the Meter freezes the display.

1. Push **HOLD** to activate Display HOLD. (**HOLD** shows on the display.)
2. To exit and return to normal operation, push **HOLD** or turn the rotary switch.



## Backlight

Push  to toggle the backlight on and off.

The backlight automatically turns off after 40 seconds. To disable backlight auto-off, see [Power-Up Options](#).

## Manual and Autoranging

The Meter has both Manual and Autorange modes. The Meter defaults to Autorange. To toggle between Manual and Autorange, push  for 1 second.

- In the Autorange mode, the Meter selects the range with the best resolution.
- In the Manual Range mode, you override Autorange and select the range yourself. Push  for 1 second to enter Manual range. (**Manual** shows on the display.) Push  to increment the range. After the highest range, the Meter wraps to the lowest range.





### Note

*You cannot manually change the range in the MIN MAX AVG or Display HOLD modes. If you push  while in MIN MAX AVG or Display Hold, the Meter beeps twice, indicating an invalid operation and the range does not change.*

## Power-Up Options

To select a Power-Up Option, hold down the button indicated in [Table 5](#) while turning the Meter from OFF to any other function. Power-Up Options are canceled when you turn off the Meter and when sleep mode is activated.

**Table 5. Power-Up Options**

Button	Power-Up Options
	Turns on all display segments until button is released.
	Disables beeper. <b>bEEP</b> shows when enabled.
	Enables low impedance capacitance measurements. <b>LCAP</b> shows when enabled.
	Disables Battery Saver™ (Sleep mode). <b>PoFF</b> shows when enabled.
	Disables auto backlight off. <b>Loff</b> is displayed when enabled.

## Making Basic Measurements

When connecting the test leads to the circuit or device, connect the common (**COM**) test lead before connecting the live lead; when removing the test leads, remove the live lead before removing the common test lead.

### ⚠⚠ Warning

**To prevent electric shock, injury, or damage to the Meter, disconnect circuit power and discharge all high-voltage capacitors before testing resistance, continuity, diodes, or capacitance.**

## Measuring Resistance

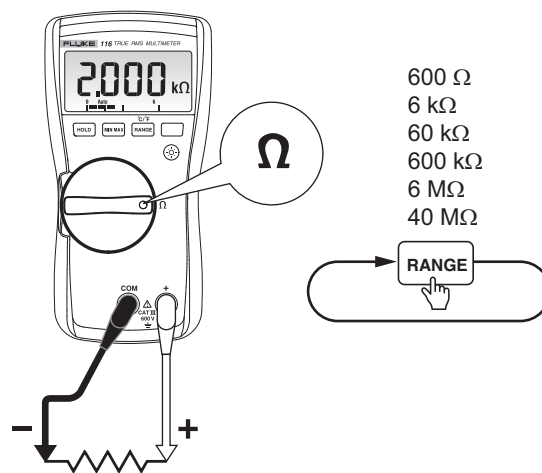

## Testing for Continuity

### Note

*Use the continuity function as a fast, convenient method to check for opens and shorts. For maximum accuracy in making resistance measurements, use the Meter's resistance ( $\Omega$ ) function.*

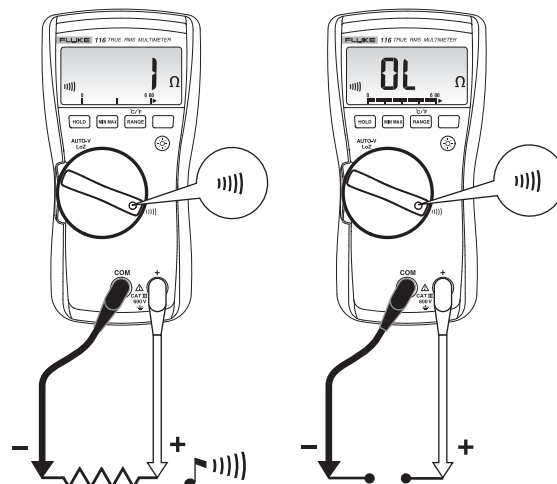

## Measuring AC and DC Voltage

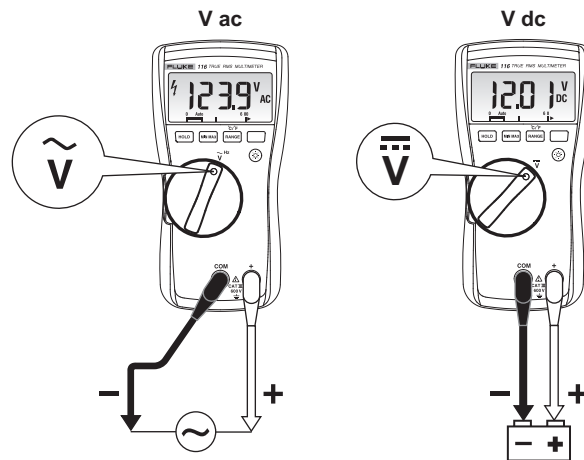

### Using Auto Volts Selection

With the function switch in the  $\text{AUTO-V}_{\text{LoZ}}$  position, the Meter automatically selects a dc or ac voltage measurement based on the input applied between the **V** or **+** and **COM** jacks.

This function also sets the Meter's input impedance to approximately 3 k $\Omega$  to reduce the possibility of false readings due to ghost voltages.

### Measuring AC and DC Millivolts

With the function switch in the  $\text{mV}_{\text{---}}$  position, the Meter measures ac plus dc millivolts. Press  to set the Meter to dc millivolts.

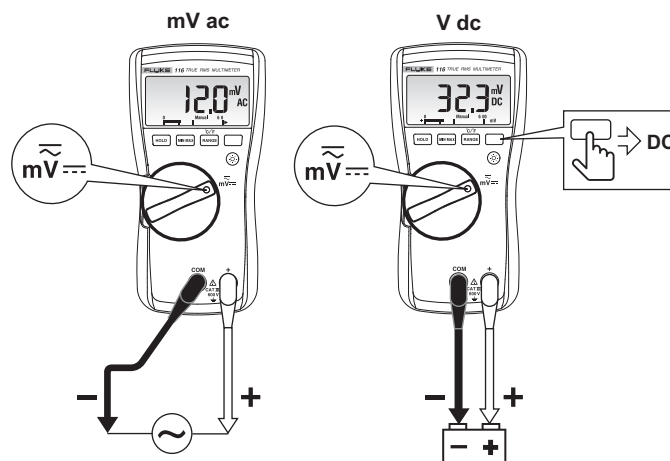

## Measuring AC or DC Current

### ⚠⚠ Warning

To avoid personal injury or damage to the Meter:

- Never attempt to make an in-circuit current measurement when the open-circuit potential to earth is >600 V.
- Use the proper terminals, switch position, and range for your measurement.

To measure flame rectification circuits:

1. Turn the function switch to  $\overline{\mu\text{A}} \sim$ .
2. Connect the Meter between the flame sensor probe and the control module.
3. Turn heating unit on and record  $\mu\text{A}$  measurement.

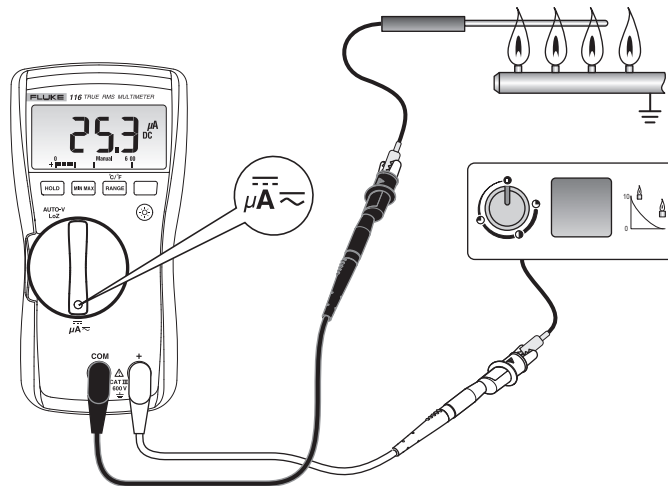

## Measuring Capacitance

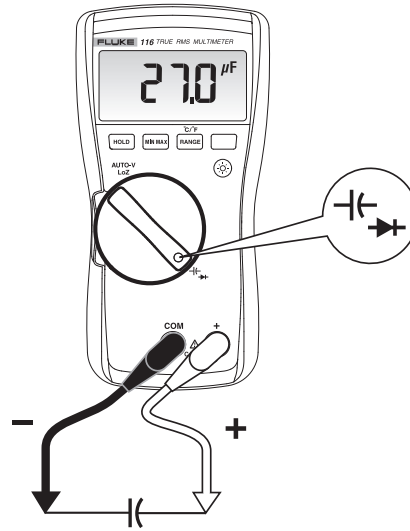

## Measuring Temperature

**⚠️ ⚠️ Warning**

To prevent risk of electric shock, do NOT connect 80BK to live circuits.

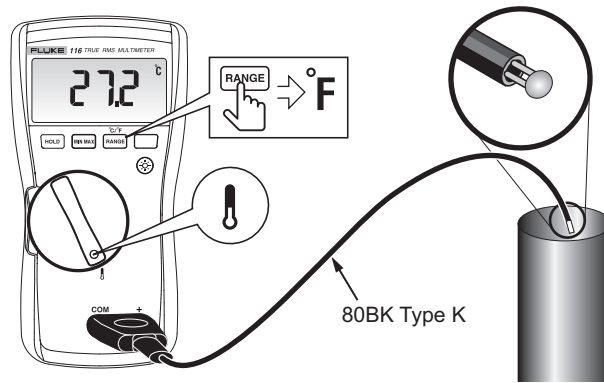

## Measuring Frequency

### ⚠⚠ Warning

To prevent electrical shock, disregard the bar graph for frequencies >1 kHz. If the frequency of the measured signal is >1 kHz, the bar graph and  $f$  are unspecified.

The Meter measures the frequency of a signal by counting the number of times the signal crosses a trigger level each second. The trigger level is 0 V, 0 A for all ranges.

Press  to turn on or turn off the frequency measurement function on and off. Frequency works with ac functions only.

In frequency, the bar graph and range annunciator indicate the ac voltage or current present.

Select progressively lower ranges using manual ranging for a stable reading.

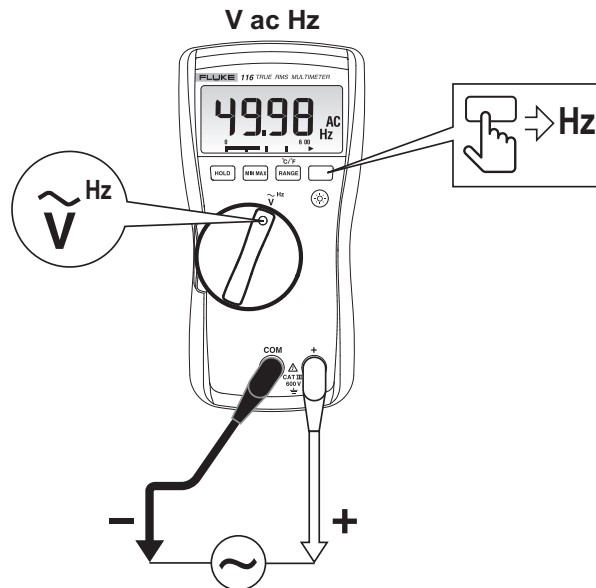

## Making Low Impedance Capacitance Measurements

For making capacitance measurements on cables with ghost voltage:

1. Hold  as you turn on the Meter to enable the low-input impedance Capacitance mode.
2. Wait until **LCAP** shows on the display.

In this mode, capacitance measurements will have a lower accuracy and lower dynamic range.

### Note

*This setting is not saved when the Meter is turned off or goes into sleep mode.*

## Testing Diodes

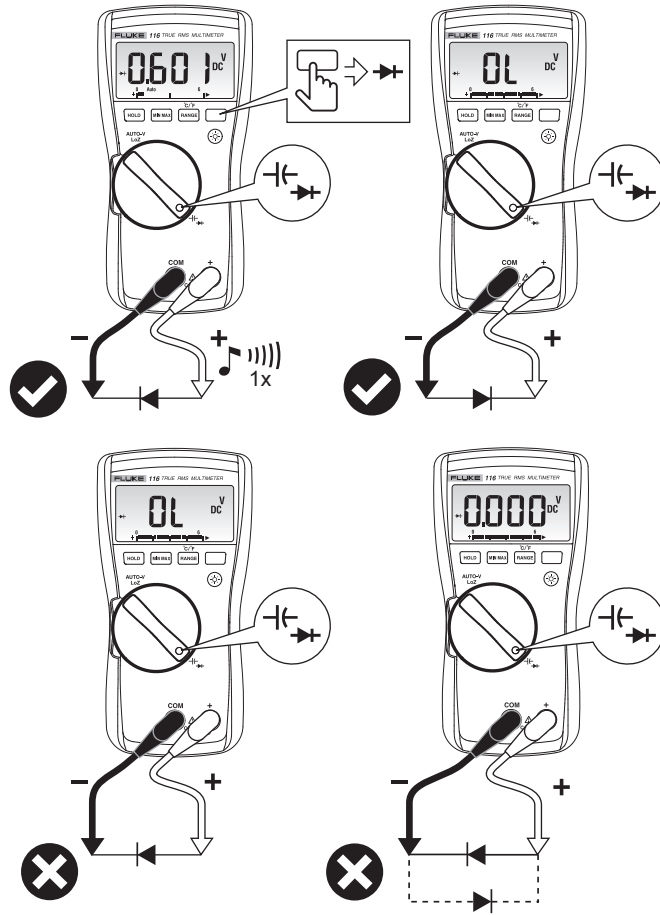



## Measuring Current above 600 $\mu\text{A}$

The millivolt and voltage function of the Meter can be used with an optional mV/A output Current Probe to measure currents that exceed the rating of the Meter. Make sure the Meter has the correct function, AC or DC, selected for your current probe. Refer to a Fluke catalog or contact your local Fluke representative for compatible current clamps.

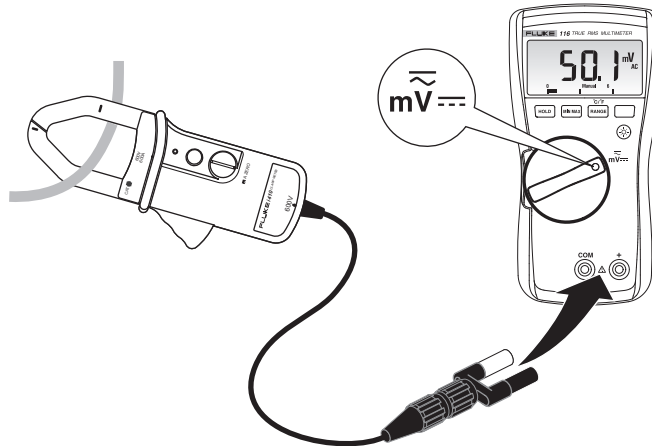

## Using the Bargraph

The bar graph is like the needle on an analog meter. It has an overload indicator (▶) to the right and a polarity indicator (⊕) to the left.

Because the bar graph is much faster than the digital display, the bar graph is useful for making peak and null adjustments.

The bar graph is disabled when measuring capacitance. In frequency, the bar graph and range annunciator indicates the underlying voltage or current up to 1 kHz.

The number of segments indicates the measured value and is relative to the full-scale value of the selected range.

In the 60 V range, for example (see below), the major divisions on the scale represent 0, 15, 30, 45, and 60 V. An input of -30 V turns on the negative sign and the segments up to the middle of the scale.



## Maintenance

Maintenance of the Meter consists of battery replacement and case cleaning.

### Replacing the Battery

#### **⚠️⚠️ Warning**

**To prevent shock, injury, or damage to the Meter, remove test leads from the Meter before opening the case or battery door.**

See [Figure 1](#) for disassembly.

**Figure 1. Disassembly**

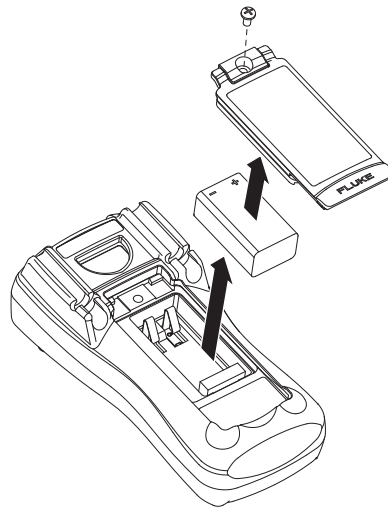

To remove the battery door for battery replacement:

1. Remove the test leads from the Meter.
2. Remove the battery door screw.
3. Use the finger recess to lift the door slightly.
4. Lift the door straight up to separate it from the case.
5. The battery fits inside the battery door, which is then inserted into the case, bottom edge first, until it is fully seated. Do not attempt to install the battery directly into the case.
6. Install and tighten battery door screw.

### Cleaning

Wipe the case with a damp cloth and mild detergent. Dirt or moisture in the terminals can affect readings.

## Specifications

Accuracy is specified for 1 year after calibration, at operating temperatures of 18 °C to 28 °C, with relative humidity at 0 % to 90 %.

Extended specifications are available at [www.fluke.com](http://www.fluke.com).

Maximum voltage between any terminal and earth ground.....	600 V
Display	
Digital.....	6000 counts, updates 4/s
Bar Graph.....	33 segments, updates 32/s
Temperature	
Operating.....	-10 °C to 50 °C
Storage.....	-40 °C to 60 °C
Temperature Coefficient.....	0.1 x (specified accuracy)/°C (<18 °C or >28 °C)
Altitude	
Operating.....	2000 meters
Storage.....	10 000 meters
Relative Humidity.....	95 % to 30 °C, 75 % to 40 °C, 45 % to 50 °C
Battery.....	IEC 6LR61
Battery Life.....	400 hours typical, without backlight
Safety.....	IEC 61010-1: Pollution Degree 2 IEC 61010-2-033 Measurement CAT III 600 V
Ingress Protection.....	IEC 60529: IP42 (non-operating)
Electromagnetic Compatibility (EMC)	
International.....	IEC 61326-1: Portable Electromagnetic Environment CISPR 11: Group 1, Class A
	<i>Group 1: Equipment has intentionally generated and/or uses conductively-coupled radio frequency energy that is necessary for the internal function of the equipment itself.</i>
	<i>Class A: Equipment is suitable for use in all establishments other than domestic and those directly connected to a low-voltage power supply network that supplies buildings used for domestic purposes. There may be potential difficulties in ensuring electromagnetic compatibility in other environments due to conducted and radiated disturbances.</i>
	<i>Caution: This equipment is not intended for use in residential environments and may not provide adequate protection to radio reception in such environments.</i>
	<i>Emissions that exceed the levels required by CISPR 11 can occur when the equipment is connected to a test object.</i>
Korea (KCC).....	Class A Equipment (Industrial Broadcasting & Communication Equipment)
	<i>Class A: Equipment meets requirements for industrial electromagnetic wave equipment and the seller or user should take notice of it. This equipment is intended for use in business environments and not to be used in homes.</i>
USA (FCC).....	47 CFR 15 subpart B. This product is considered an exempt device per clause 15.103.

**Table 6. Accuracy Specifications**

Function	Range	Resolution	Accuracy ± ([% of Reading] + [Counts])	
DC Millivolts	600.0 mV	0.1 mV	0.5 % + 2	
DC Volts	6.000 V	0.001 V	0.5 % + 2	
	60.00 V	0.01 V		
	600.0 V	0.1 V		
			<b>DC, 45 to 500 Hz</b>	<b>500 Hz to 1 kHz</b>
Auto-V LoZ <sup>[1]</sup> True-rms	600.0 V	0.1 V	2.0 % + 3	4.0 % + 3
			<b>45 to 500 Hz</b>	<b>500 Hz to 1 kHz</b>
AC millivolts <sup>[1]</sup> True-rms	600.0 mV	0.1 mV	1.0 % + 3	2.0 % + 3
AC Volts <sup>[1]</sup> True-rms	6.000 V	0.001 V	1.0 % + 3	2.0 % + 3
	60.00 V	0.01 V		
	600.0 V	0.1 V		
Continuity	600 Ω	1 Ω	Beeper on <20 Ω, off >250 Ω. Detects opens or shorts of 500 μs or longer.	
Ohms	600.0 Ω	0.1 Ω	0.9 % + 2	
	6.000 kΩ	0.001 kΩ	0.9 % + 1	
	60.00 kΩ	0.01 kΩ	0.9 % + 1	
	600.0 kΩ	0.1 kΩ	0.9 % + 1	
	6.000 MΩ	0.001 MΩ	0.9 % + 1	
	40.00 MΩ	0.01 MΩ	5.0 % + 2	
Diode Test	2.000 V	0.001 V	0.9 % + 2	
Capacitance	1000 nF	1 nF	1.9 % + 2	
	10.00 μF	0.01 μF	1.9 % + 2	
	100.0 μF	0.1 μF	1.9 % + 2	
	9999 μF	1 μF	100 μF - 1000 μF: 1.9 % + 2 >1000 μF: 5 % + 20	
Lo-Z Capacitance (Power-up option)	1 nF to 500 μF		10 % + 2 typical	
Temperature (Type K Thermocouple)	-40 °C to 400 °C	0.1 °C	1 % + 10 <sup>[2]</sup>	
	-40 °F to 752 °F	0.2 °F	1 % + 18 <sup>[2]</sup>	
AC μAmps True-rms <sup>[1]</sup> (45 Hz to 500 Hz)	600.0 μA	0.1 μA	1.5 % + 3 (2.5 % + 3 >500 Hz)	
DC μAmps	600.0 μA	0.1 μA	1.0 % + 2	

**Table 6. Accuracy Specifications (cont.)**

Function	Range	Resolution	Accuracy ± ([% of Reading] + [Counts])
Hz (V or A input) <sup>[3]</sup>	99.99 Hz	0.01 Hz	0.1 % + 2
	999.9 Hz	0.1 Hz	
	9.999 kHz	0.001 kHz	
	50.00 kHz	0.01 kHz	

Notes:

- [1] All ac ranges except Auto-V LoZ are specified from 1 % to 100 % of range. Auto-V LoZ is specified from 0.0 V. Because inputs below 1 % of range are not specified, it is normal for this and other true-rms meters to display non-zero readings when the test leads are disconnected from a circuit or are shorted together. For volts, crest factor of ≤3 at 4000 counts, decreasing linearly to 1.5 at full scale. For amps, crest factor of ≤3. AC volts is ac-coupled. Auto-V LoZ, AC mV, and AC amps are dc-coupled.
- [2] AC Volts Hz is ac-coupled and specified from 5 Hz to 99.99 kHz. Minimum input required above 50.00 kHz typically is >1.1 vac sine. Minimum input typical and not specified. AC Amps Hz is dc-coupled and specified from 45 Hz to 5 kHz.
- [3]  $\Delta$  >10 A unspecified. Duty cycle: >10 A to 20 A, 30 seconds on, 10 minutes off.

**Table 7. Input Characteristics**

Function	Input Impedance (Nominal)	Common Mode Rejection Ratio (1 k $\Omega$ Unbalanced)		Normal Mode Rejection
Volts AC	>5 M $\Omega$ <100 pF	>60 dB at dc, 50 or 60 Hz		- - -
Volts DC	>10 M $\Omega$ <100 pF	>100 dB at dc, 50 or 60 Hz		>60 dB at dc, 50 or 60 Hz
Auto-V LoZ	~3 k $\Omega$ <500 pF	>60 dB at dc, 50 or 60 Hz		- - -
	<b>Open Circuit Test Voltage</b>	<b>Full Scale Voltage</b>		<b>Short Circuit Current</b>
Ohms	<2.7 V dc	<b>to 6.0 M<math>\Omega</math></b>	<b>40 M<math>\Omega</math></b>	<350 $\mu$ A
		<0.7 V dc	<0.9 V dc	
Diode Test	<2.7 V dc	2.000 V dc		<1.2 mA

