

HIOKI

FT6031-50

Instruction Manual

EARTH TESTER



EN

May 2021 Revised edition 1
FT6031B961-01 21-05H



* 6 0 0 6 0 1 3 7 1 *

Contents

Introduction.....	1
Verifying Package Contents	5
Options (sold separately)	6
Safety Notes.....	7
Usage Notes.....	10

1 Overview 15

1.1 Overview and Features	15
Overview.....	15
Features.....	15
1.2 Part Names and Functions.....	17
1.3 How to Use Carrying Case	24

2 Preparing for Measurement 25

2.1 Attaching/Removing Protector	25
2.2 Inserting/Replacing Batteries	26
Procedure	28
2.3 Connecting the Z3210 Wireless Adapter (Option)	29
Procedure	30

3 Making Measurements 31

3.1 Measurement Procedure	31
3.2 Inspecting Before Use	32
3.3 Setting Up Comparator (PASS/FAIL Test) ...	36
How to set up comparator.....	37
How to disable comparator	37

3.4	Precise Measurement for Earth Resistance (Precise Measurement Method, 3-pole Method)	38
	Performing zero adjustment.....	40
	Connecting measurement cables to the earthing electrodes	42
	Measuring earth resistance	46
	Stowing	49
	Continuous measurement function	50
3.5	Simplified Measurement for Earth Resistance (Simplified Measurement Method, 2-pole Method)	52
	Performing zero adjustment.....	55
	Connecting test leads to the object under measurement.....	57
	Measuring earth resistance	59
	Stowing	59
3.6	Cautions and Tips for Measurement	60
	Distance between earthing electrodes.....	60
	Location to install auxiliary earthing rod.....	61
	How to insert/pull out auxiliary earthing rod.....	62
3.7	Auto Power Save (Power-saving Function)	64
3.8	Wireless Communications Function (GENNECT Cross)	65
3.9	Excel[®] Direct Entry Function (HID Function)	67
3.10	Activating the LCD All-on Display	70
3.11	Displaying the Serial Number	71
3.12	Displaying the Version number	72
	Update function.....	72

4	Specifications	73
4.1	General Specifications	73
4.2	Input, Output, and Measurement Specifications	75
5	Maintenance and Service	83
5.1	Repair, Inspection, and Cleaning.....	83
5.2	Troubleshooting	85
5.3	Error and Status Codes	89
6	Appendix	91
6.1	Earth Resistance	91
6.2	Measurement Principle	93

Warranty Certificate

Introduction

Thank you for choosing the HIOKI FT6031-50 Earth Tester. To ensure your ability to get the most out of this instrument over the long term, please read this manual carefully and keep it available for future reference.

Carefully read the separate document entitled “Operating Precautions” before use.

Intended audience

This manual has been written for use by individuals who use the instrument or provide information about how to use the instrument. In explaining how to use the instrument, it assumes electrical knowledge (equivalent of the knowledge possessed by a graduate of an electrical program at a technical high school).







Trademarks

- Microsoft Windows and Excel are either registered trademarks or trademarks of Microsoft Corporation in the United States and other countries.
- The Bluetooth® word mark and logos are registered trademarks owned by Bluetooth SIG, Inc. and any use of such marks by Hioki E.E. Corporation is under license. Other trademarks and trade names are those of their respective owners.





Notations

Safety notations



In this document, the severity levels of risk and hazard are classified as follows:

 DANGER	Indicates an imminently hazardous situation that will result in death of or serious injury to the operator.
 WARNING	Indicates a potentially hazardous situation that may result in death of or serious injury to the operator.
 CAUTION	Indicates a potentially hazardous situation that may result in minor or moderate injury to the operator or damage to the instrument or malfunction.
IMPORTANT	Indicates information or content that is particularly important from the standpoint of operating or maintaining the instrument.
	Indicates a high-voltage hazard. Failure to verify safety or improper handling of the instrument could lead to an electric shock, burn, or death.
	Indicates an action that must not be performed.
	Indicates an action that must be performed.

Symbols affixed to the instrument

	Indicates the need for caution or the presence of danger. For more information about locations where this symbol appears on instrument components, see the “Usage Notes” section (p. 10), warning messages listed at the beginning of operating instructions , and accompanying the document entitled “Operating Precautions.”
	Indicates a double-insulated device.
	Indicates DC (Direct Current).
	Indicates AC (Alternating Current).
	Indicates the power button that switches the instrument between on and off states.

Symbols for various standards

	Indicates the Waste Electrical and Electronic Equipment Directive (WEEE Directive) in EU member states.
	Indicates that the product conforms to regulations required by the EU Directive.

Other notations

*	Instructs the reader to see below for additional information.
(p.)	Indicates the page number to reference.
Fn	Operation key names are highlighted in bold .

Screen display

The instrument screen displays the alphanumeric characters as follows:

A	B	C	D	E	F	G	H	I	J	K	L	M	N	O	P	Q	R	S	T	U	V	W	X	Y	Z
A	b	C	d	E	F	G	H	I	J	K	L	M	N	O	P	Q	R	S	T	U	V	W	X	Y	Z
1	2	3	4	5	6	7	8	9	0																
1	2	3	4	5	6	7	8	9	0																

Accuracy

Hioki expresses accuracy as error limit values specified in terms of percentages relative to reading and full scale, and digits.

Reading	(Displayed value) Refers to the displayed value of the measuring instrument. The limit values of reading errors are expressed in percent of reading (% of reading, % rdg).
Full scale	(Maximum displayable value) Refers to the maximum displayable value of each measurement range. The instrument has measurement ranges whose values are equal to the maximum displayable values. The limit values of full-scale errors are expressed in percent of full scale (% of full scale, % f.s.).
Digits	(Resolution) Refers to the smallest change in the indication on the digital measuring instrument, i.e., the numeral one in the rightmost place. The limit values of digit errors are expressed in terms of digits (dgt).

Verifying Package Contents

When you open the package, carefully inspect the instrument to ensure that everything is in good condition, and that no damage occurred during shipping. Carefully check the accessories, panel keys, and connectors. If the instrument seems to have been damaged or does not work as specified, contact your authorized Hioki distributor or reseller.

Check the package contents as follows.

FT6031-50

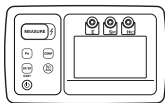











Accessories

- L9840** Auxiliary Earthing Rod (2 piece set) ×1
- L9841** Measurement Cable (alligator clip, black 4 m) ×1
- L9842-11** Measurement Cable (yellow 10 m, equipped with winder) ×1
- L9842-22** Measurement Cable (red 20 m, equipped with winder) ×1
- C0106** Carrying Case ×1
- Protector**
- AA alkaline battery (LR6) ×4**
- Instruction Manual**
- Operating Precautions (0990A907)**

Options (sold separately)

The options listed below are available for the instrument. To order an option, please contact your authorized Hioki distributor or reseller. Options are subject to change. Please check Hioki's website for the latest information.

L9787	Test Lead (for simplified measurement method, indoor use only, red and black 1.2 m each)	
L9840	Auxiliary Earthing Rod (for precision measurement method, 2 pcs in 1 set) (ϕ 6 mm, entire length of 270 mm, straight section 235 mm, material: stainless SUS304)	
L9841	Measurement Cable (for precision measurement method, alligator clip, black 4 m)	
L9842-11	Measurement Cable (for precision measurement method, yellow 10 m, equipped with winder)	
L9842-22	Measurement Cable (for precision measurement method, red 20 m, equipped with winder)	
L9843-51	Measurement Cable (for precision measurement method, yellow 50 m, equipped with flat cable winder)	
L9843-52	Measurement Cable (for precision measurement method, red 50 m, equipped with flat cable winder)	
L9844	Measurement Cable (for earthing terminal board, alligator clip, 3 cables in 1 set, red/yellow/black 1.2 m each)	
9050	Earth Nets (2 sheets in 1 set, 300 mm \times 300 mm)	
C0106	Carrying Case	
Z3210	Wireless Adapter	

Safety Notes

This instrument is designed to conform to IEC 61010 Safety Standards, and has been thoroughly tested for safety prior to shipment. However, using the instrument in a way not described in this manual may negate the provided safety features. Carefully read the following safety notes before using the instrument.

DANGER



Mishandling during use could result in injury or death, as well as damage to the instrument. Familiarize yourself with the instructions and precautions in this manual before use.

WARNING



Electricity can potentially cause serious events such as an electric shock, heat generation, fire, and an arc flash due to a short-circuit. If you have not used any electrical measuring instruments before, you should be supervised by a technician who has experience in electrical measurement.

Measurement categories

To ensure safe operation of measuring instruments, IEC 61010 specifies the measurement categories, which classifies testing and measuring circuits into three categories according to the types of mains circuits to which they are intended to be connected.

DANGER



- **Do not use a measuring instrument for measurements on a mains circuit that exceeds the range of the measurement category rated for the instrument. Failure to observe this can cause a severe accident.**
- **Do not use a measuring instrument without a measurement category rating for measurements on a mains circuit. Failure to observe this can cause a severe accident.**

This instrument conforms to the safety requirements for CAT II 300 V, CAT III 150 V, CAT IV 100 V measuring instruments.

Measurement category II (CAT II)

Applicable to test and measuring circuits connected directly to utilization points (socket outlets and similar points) of the low-voltage mains installation.

Example: Measurements on household appliances, portable tools, and similar equipment, and on the consumer side only of socket-outlets in the fixed installation.

Measurement category III (CAT III)

Applicable to test and measuring circuits connected to the distribution part of the building's low-voltage mains installation.

Example: Measurements on distribution boards (including secondary meters), photovoltaic panels, circuit breakers, wiring, including cables, bus-bars, junction boxes, switches, socket-outlets in the fixed installation, and equipment for industrial use and some other equipment such as stationary motors with permanent connection to the fixed installation.

Measurement category IV (CAT IV)

Applicable to test and measuring circuits connected at the source of the building's low-voltage mains installation.

Example: Measurements on devices installed before the main fuse or circuit breaker in the building installation.

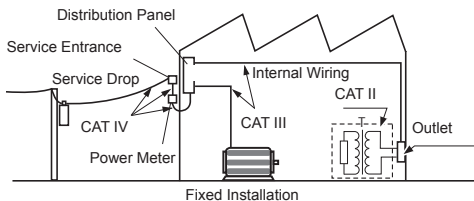

Usage Notes

Observe the following precautionary information to ensure that the instrument can be used safely and in a manner that allows it to perform as described in its specifications.

Use of the instrument should confirm not only to its specifications, but also to the specifications of all accessories, options, batteries, and other equipment in use.

Verifying before usage

DANGER

If the test lead or the instrument is damaged, there is a risk of an electric shock. Perform the following inspection before use:



- **Check that the insulation of the test leads are neither ripped nor torn and that no metal parts are exposed. Using the instrument under such conditions could result in an electric shock. Replace the test leads with those specified by Hioki.**
- **Check the instrument for any damage that may have occurred during storage or shipping, and perform functional checks before use.**

Use environment of the instrument

WARNING

Installing the instrument in inappropriate locations may cause a malfunction of instrument or may give rise to an accident. Avoid the following locations that are:



- Exposed to direct sunlight or high temperatures
- Exposed to corrosive or combustible gases
- Exposed to strong electromagnetic fields or electrostatic charges
- Near induction heating systems (such as high-frequency induction heating systems and IH cooking equipment)
- Susceptible to vibration
- Exposed to water, oil, chemicals, or solvents
- Exposed to high humidity or condensation
- Exposed to high concentrations of dust particles

CAUTION



- Do not place the instrument on an unstable or uneven surface. Doing so could cause the instrument to fall or turn over, causing bodily injury or damage to the instrument.



- Do not place the instrument on an unstable or uneven surface. Doing so could cause the instrument to fall or turn over, causing bodily injury or damage to the instrument.

The protection rating for the enclosure of the instrument (based on EN60529) is IP65/67*.

CAUTION

Although the instrument has a dust-proof, jet-proof and waterproof structure, it is not for completely shutting out the water intrusion into the inside. Please note that it can be a cause of failure.

***IP65/IP67:**

This indicates the degree of protection provided by the enclosure of the device against use in hazardous locations, entry of solid foreign objects, and the ingress of water.



- 6: Protected against access to hazardous parts with wire measuring 1.0 mm in diameter. Dust-proof type (Dust shall not penetrate the enclosure.)
- 5: The equipment inside the enclosure is protected against the harmful effects of water projected in jets against the enclosure from any direction.
- 7: Watertight (Quantities of water that may harm the enclosure when it is temporarily immersed in water shall not penetrate the enclosure.)

For details on the operating temperature and humidity range, see the specifications. (p.73)

Handling the cables

CAUTION



To prevent cable damage, do not step on cables or pinch them between other objects. Do not bend or pull on cables at their base.



The ends of the L9787 Test Lead and L9840 Auxiliary Earthing Rod are sharp. Be careful to avoid injury.

IMPORTANT

Use only the specified auxiliary earthing rod, cables, and test leads. Using a non-specified cable may result in incorrect measurements due to poor connection or other reasons.

Precautions during measurement

WARNING



If the instrument is used in locations where the rating indicated on the instrument or cords is exceeded, the instrument may be damaged resulting in personal injury. Do not use the instrument in such locations. See “Measurement categories” (p.8)

Precautions during shipment

Be sure to follow these precautions when transporting the instrument:

- Remove accessories and optional equipment from the instrument in order to avoid damage. Additionally, use the original packing materials, and be sure to double box the instrument. Accidental damage suffered in transit is not covered by the warranty.
- Attach a description of the issue when sending out your instrument for repair.

1.1 Overview and Features

Overview

The grounding works applied to the distribution lines and electrical facilities are essential for preventing electric shock and fire as well as for safeguarding the equipment. The instrument is an earth tester that is fully functional for measuring earth resistance for grounding works.

It is capable of providing accurate and highly reliable measurement. The instrument can provide precision measurement (3-pole method) and simplified measurement (2-pole method).

Features

High accuracy

The accuracy of the 200.0 Ω range is $\pm 1.5\%$ rdg ± 4 dgt.

Auto-range and auto-check for auxiliary earthing electrode

The measurement is performed by simply pressing the **MEASURE** button. There is no need for cumbersome range-switching. In addition, the earth potential and auxiliary earthing electrode are automatically checked.

High allowable earth resistance for auxiliary earthing electrode

The resistance that the auxiliary earthing electrode can tolerate is now about 10 times higher than the conventional level. As a result, it can provide measurement under adverse conditions.

**Dustproof,
jet-proof and
waterproof**

The instrument can withstand water at a depth of 1 m for 30 minutes.

**Supplied with
winders**

The instrument is supplied with useful winders so that it can be easily prepared and packed up before/after measurement.

**Drop-proof
(when equipped with
a protector)**

Its robust structure can withstand a drop from 1 m onto concrete surface.

1.2 Part Names and Functions

Front

1

Cover of the measurement terminals (p.49)

Protector

Removed when replacing the batteries or attaching the Z3210.
(p.25, p.28, p.30)

Measurement terminals

E Connected with the black cable.
S(P) Connected with the yellow cable.
H(C) Connected with the red cable.

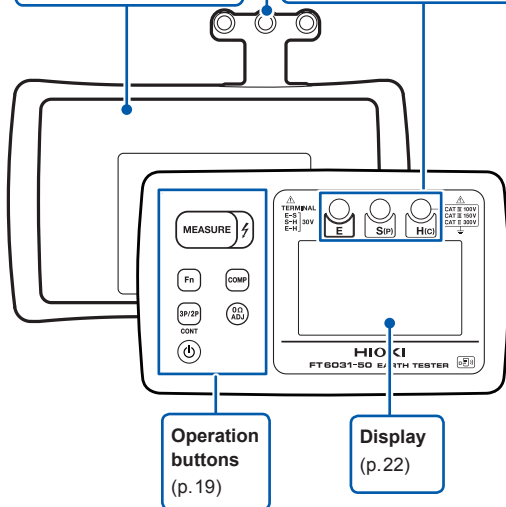

Operation buttons
(p.19)

Display
(p.22)

IMPORTANT

Please do not press the buttons of the instrument with a sharp object. It may damage the instrument.

Rear and sides

Battery cover (side view)



Waterproof seal

It needs to be replaced when degraded.
Please contact your authorized Hioki distributor or reseller.

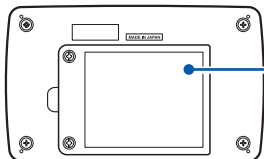

Battery cover

Removed when replacing the batteries or attaching the Z3210.
(p.28, p.30)







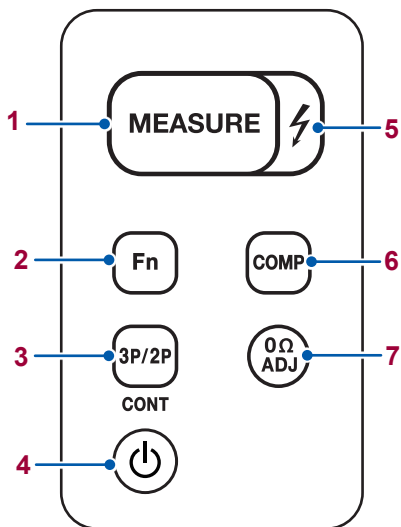

Serial number

Please do not remove the label as it is needed for product control such as product warranty etc.
The first four digits of the 9-digit number indicate the year (the first two digits omitted) and the month of manufacture.

Operation buttons



1

<p>1</p> 	<p>MEASURE button</p> <ul style="list-style-type: none"> Start/stop for measuring earth resistance
<p>2</p> 	<p>Fn button</p> <ul style="list-style-type: none"> Displays the resistance of each earthing electrode. (p.46) Display switching (3-pole method, 2-pole method) DC/AC auto switching (when measuring earth potential) Wireless communications function on/off (Press and hold for at least 1 s.)* (p.65)
<p>3</p> 	<p>3P/2P button</p> <ul style="list-style-type: none"> Switches between 3-pole method and 2-pole method. Releases the measured value when it is hold and displays the current earth potential value. Continuous measurement on/off (Press and hold for at least 1 s.)
<p>4</p> 	<p>Power button</p> <ul style="list-style-type: none"> Power on/off
<p>5</p> 	<p>Live wire warning LED</p> <ul style="list-style-type: none"> For 3-pole method Blinks under any of the following conditions: <ul style="list-style-type: none"> A voltage of 30 V or higher is applied between the S(P) and E terminals. A voltage of 85 V or higher is applied between the H(C) and E terminals. A voltage of 85 V or higher is applied between the H(C) and S(P) terminals. For 2-pole method Blinks when a voltage of 30 V or higher is applied between the H(C) and E terminals. Lights up during earth resistance measurements.
<p>6</p> 	<p>COMP button</p> <ul style="list-style-type: none"> Sets/cancels comparator setting. (The COMP indicator lights up/goes off.) (p.37) Wireless communications function on/off (Press and hold for at least 1 s.)* (p.65)





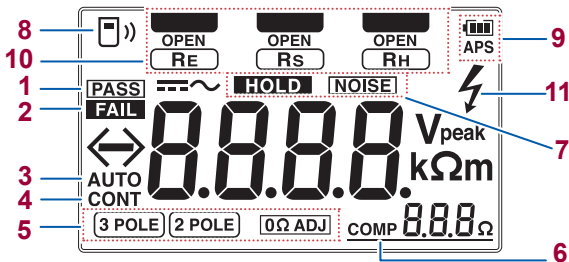

7		0ΩADJ button • Sets/cancels zero adjustment setting. (Press and hold for at least 1 s.) (p.40, p.54)
---	---	--

*: With Z3210 installed

Display



1	PASS	Comparator comparison result (PASS)
2	FAIL	Comparator comparison result (FAIL)
3	AUTO	Appears when DC/AC auto-detect setting is enabled for measuring earth potential.
4	CONT	Appears when continuous measurement function is enabled.
	3 POLE	3-pole method (p.38)
5	2 POLE	2-pole method (p.52)
	0Ω ADJ	Zero adjustment (p.40, p.55)
6	COMP	Appears when comparator setting is enabled. (p.36)
7	HOLD	Indicates that the measured value is being retained.
	NOISE	Appears when earth potential exceeds allowable range.
8		Indicates wireless communication function status*. (p.65) Flashes: Communicating Lights up: Wireless function on Lights off: Wireless function off

9		Indicates the battery level. (p.27)
	APS	Appears 30 s before auto-power-save function is activated. (p.64)
10		Indicates where to connect a measurement cable or test lead.
	OPEN	Appears when the resistance of each (auxiliary) earthing electrode is high or a measurement cable is not connected.
		Earth resistance of earthing electrode
		Earth resistance of auxiliary earthing electrode S
		Earth resistance of auxiliary earthing electrode H
11		Live wire warning indicator (Blinks during earth resistance measurements)

*: Optional Z3210 Wireless Adapter required separately

See p.89 for error display.

1.3 How to Use Carrying Case

Please store the instrument, winder and other accessories/options into the C0106 Carrying Case as shown in the figure below.

- Please do not store commercially available pegs in this carrying case as those have sharp tips. It may damage the case.
- Please do not wash the carrying case.

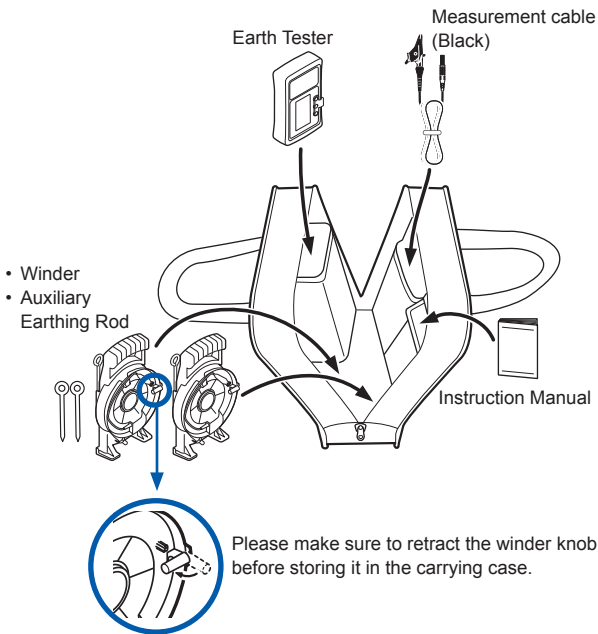

2

Preparing for Measurement

2.1 Attaching/Removing Protector

Attaching the protector

Tilt the instrument and slide it into the protector, and then push the entire instrument into the protector.

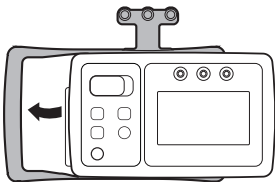

Removing the protector

Hold it with both hands and push the one end of the protector down.

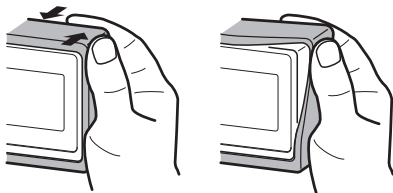

IMPORTANT

If the protector is removed, the drop-proofness (p.73) will be void.

2.2 Inserting/Replacing Batteries

Before using the instrument, insert four AA alkaline batteries (LR6). Before measurements, check that the battery level is sufficient. When the battery charge is low, replace the batteries.

WARNING



- **To avoid electric shock, turn off the instrument and disconnect the measurement cables or test leads before replacing batteries.**



- **Batteries may explode if mistreated. Do not short-circuit, disassemble the batteries, or dispose of them in fire. Do not recharge alkaline batteries. Handle and dispose of batteries in accordance with local regulations.**



- **After inserting the batteries, reattach the cover, screws, and put on the protector before using the instrument.**
- **To prevent instrument damage or an electric shock, use only the screws that are originally installed for securing the battery cover in place. If you have lost any screws or find that any screws are damaged, please contact your authorized Hioki distributor or reseller.**

CAUTION





Poor performance or damage from battery leakage could result. Observe the cautions listed below.



- Do not mix old and new batteries, or different types of batteries
- Pay attention to the polarity markings “+” and “-”, so that you do not insert the batteries the wrong way around.
- Do not use batteries after their recommended expiry date.
- Do not leave a depleted batteries inside the instrument.
- Replace batteries only with the specified type.
- Remove the batteries from the instrument if it is to be stored for a long time.

- The  indicator flashes when the remaining battery capacity is low. In this case, measurement is not possible. Replace the batteries.
- After use, always turn off the instrument.
- Although rechargeable batteries (nickel-hydride) can be used for measurement, the battery level indicator will not be accurately displayed.
- When replacing the batteries after cleaning, the replacement should be carried out after the instrument has been completely dried.
- The operating temperature of the batteries included in the shipment is -10°C to 45°C (14°F to 113°F). When using the instrument outside this temperature range, use batteries that can support such a low or high temperature range. (Example: lithium battery)

Battery warning indicator

	Fully charged.
	As the battery charge diminishes, black charge bars disappear, one by one, from the left of the battery indicator.
	The battery voltage is low. Replace the batteries as soon as possible.
	(Blinks) The battery is exhausted. Replace the batteries.

Procedure

You will need:

- Phillips-head screwdriver (No. 2)
- AA alkaline battery (LR6) ×4

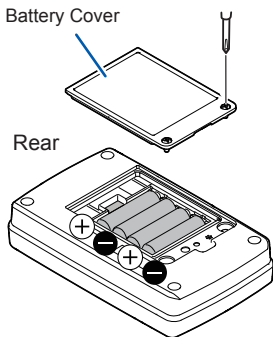

- 1** Turn off the instrument and remove the measurement cables or test leads from the instrument.
- 2** Remove the protector. (p.25)
- 3** Unscrew the screws of the battery cover with a Phillips-head screwdriver.
- 4** Remove the battery cover. Do not remove the waterproof seal from the battery cover. (p. 18)
- 5** When replacing the batteries, all of the old batteries should be removed.
- 6** Pay attention to the polarities of the batteries when inserting four new batteries (LR6).
- 7** Reattach the battery cover and tighten the screws.
- 8** Attach the protector. (p.25)

2.3 Connecting the Z3210 Wireless Adapter (Option)

The wireless communications function can be used by connecting the Z3210 Wireless Adapter (option) to the instrument.

See “3.8 Wireless Communications Function (GENNECT Cross)” (p.65).

WARNING



- To avoid electric shock, turn off the instrument and disconnect the measurement cables or test leads before replacing batteries.
- After connecting the Z3210, reattach the cover, screws, and put on the protector before using the instrument.
- To prevent instrument damage or an electric shock, use only the screws that are originally installed for securing the battery cover in place. If you have lost any screws or find that any screws are damaged, please contact your authorized Hioki distributor or reseller.



CAUTION



Before handling the Z3210, eliminate static electricity from your body by touching any metallic part, such as a doorknob. Failure to do so could cause static electricity to damage the Z3210.

Procedure

You will need:

- Phillips-head screwdriver (No. 2)
- Flat-head screwdriver
- Z3210 Wireless Adapter

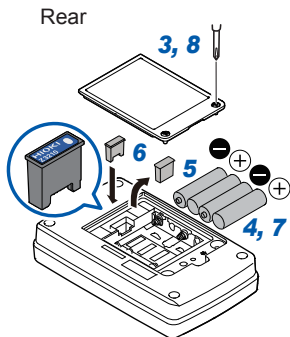

Use a flat-head screwdriver or other suitable tool to remove the Z3210.

- 1** Turn off the instrument and remove the measurement cables or test leads from the instrument.
- 2** Remove the protector. (p.25)
- 3** Unscrew the screws of the battery cover with a Phillips-head screwdriver and Remove the battery cover. Do not remove the waterproof seal from the battery cover. (p. 18)
- 4** Remove the batteries from the instrument
- 5** Remove the protective cap with a flathead screwdriver.
- 6** Exercising care to orient the Z3210 correctly, install the Z3210 as far as it will go.
- 7** Exercising care to the polarities of the batteries when inserting them to the instrument.
- 8** Reattach the battery cover and tighten the screws.
- 9** Attach the protector. (p.25)

3.1 Measurement Procedure

Before using the instrument, be sure to read “Usage Notes” (p. 10).

Preparing for measurement

Insert the batteries. (p.26)

Perform the startup check. (p.32)

As necessary, have other optional items available and ready.

Measurement

Turn the power on and select the measurement method.

Connect measurement cables or test leads to the measurement terminals.

Perform zero adjustment.
(3-pole method [p. 40],
2-pole method [p. 55])

Start the measurement.

Finishing the measurement

Turn the power off and remove measurement cables or test leads from the object under measurement.

3.2 Inspecting Before Use

Check the instrument/device for any damage that may have occurred during storage or shipping, and perform functional checks before use. If you find any damage to the instrument, please contact your authorized Hioki distributor or reseller for repair.

Check items	Solution
Is the battery level sufficient?	Check the battery level indicator on the upper right corner while the power has been turned on. If  is blinking, the battery level is low. Replace the batteries with new ones. (p.26)
Is there any missing segment in the display items?	Check by activating the LCD all-on display. (p.70) If there is a missing segment, the instrument needs to be repaired.
Is there any damage or crack in the instrument?	Conduct visual checking. If damage is found, the instrument should not be used and needs to be repaired as it can cause electric shock.
Is there any foreign material (sand etc.) inside the measurement terminals?	Remove all foreign materials if any. If it cannot be removed, the instrument needs to be repaired.
Is there any damage or exposed internal white part or metal in the coating of measurement cable or test lead?	If damage is found, it should not be used and needs to be replaced as it can cause electric shock.

Check items	Solution
<p>Use the following method to check whether the measurement cable or test lead has a break.</p> <p>1. For 3-pole method Press the 3P/2P button to display 3 POLE.</p> <p>For 2-pole method Press the 3P/2P button to display 2 POLE.</p> <p>2. Connect measurement cables or test leads to the instrument and short circuit their tips.</p> <p>3. Press the MEASURE button to check that approx. 0 Ω is indicated.</p>	<p>If not indicating approx. 0 Ω</p> <ul style="list-style-type: none"> • The measurement cable or test lead has not been fully inserted. →Fully insert the cord or lead. • The measurement cable or test lead may have a break. →Replace it with another lead that is specified by Hioki. If the symptom persists even after the measurement cable or test lead is replaced, the instrument may have a failure. The instrument needs to be repaired.



DANGER



- **Connect the instrument to the secondary side of a distribution panel. If a short-circuit occurs on the secondary side of the distribution panel, the panel will interrupt the short-circuit current. Do not connect the instrument to the primary side of the distribution panel because an unrestricted current flow can damage the instrument and facilities if a short-circuit occurs.**
- **Do not cause a short-circuit between another wire and the wire to be measured with the test leads. Arcs or such grave accidents are likely to occur.**
- **To prevent a short-circuit or electric shock, do not touch the metal part of the connecting test leads tip.**



WARNING



- **To prevent an electric shock, confirm that any of the white or red portion (insulation layer) of the L9787 Test Lead and the L9844 Measurement Cable is not exposed. If the cable is exposed, do not use the cable.**

 **WARNING**

To prevent an electric shock, observe the following precautions:

- Prior to measurement, please make sure that the earthing electrode has been disconnected from the distribution system. The Measurement Cables L9841, L9842-11, L9842-22, L9843-51 and L9843-52 are measurement cables with the maximum rated voltage of 30 V (between input terminals and the ground) and are designed to measure the earth resistance of an earthing electrode disconnected from the distribution system.
- Turn off all power before connecting measurement cables and test leads.
- Connect measurement cables or test leads to terminals securely. If a terminal is loose, the contact resistance will increase, resulting in overheating, equipment burnout, or a fire.



3

 **CAUTION**

- To avoid damaging the measurement cables or test leads, unplug them by grasping the connectors, not the cables or cords.



3.3 Setting Up Comparator (PASS/FAIL Test)

The instrument has a comparator function, which can indicate PASS or FAIL with the display indicator and beep. The earth resistance can be measured without setting up the comparator.

The comparator function operates as follows:

Comparison result	Display	Beep
Measured value \leq Reference value (PASS)	PASS	Intermittent
Measured value $>$ Reference value (FAIL)	FAIL	Continuous

The comparison reference value can be chosen from the reference values in the following table.

Reference value (Ω)					
1	2	3	4	5	
6	7	8	9		
10	20	30	40	50	
60	70	80	90		
100*	200	300	400	500	OFF

*: Default

How to set up comparator

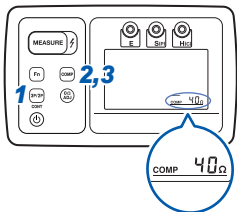

1 Press the **3P/2P** button to set to **3 POLE** (3-pole method), or **2 POLE** (2-pole method).

2 Press the **COMP** button.

The **COMP** indicator blinks, and the resistance for the comparison reference appears.

3 Press the **COMP** button again and then choose a comparison reference.

If there is no operation for approx. 2 s after the desired comparison reference has been chosen, the comparator is enabled and the **COMP** indicator appears in the display.

The comparator setting is saved even after the power is turned off.

How to disable comparator

1 Press the **COMP** button while the comparator has been enabled.

The **COMP** indicator blinks.

2 Press the **COMP** button several times until the **OFF** indicator appears on the display.

The comparator will be disabled if no button is pressed for about 2 s after the OFF indicator appears on the display.

3.4 Precise Measurement for Earth Resistance (Precise Measurement Method, 3-pole Method)

WARNING



The instrument can output a voltage of approx. 30 V. Although the instrument has a dustproof, jet-proof and waterproof structure, the instrument should always be dried before using it for measurement so as to avoid electric shock.

CAUTION



Do not connect the measurement cables if any foreign material remains inside the measurement terminals. It may cause failure.

There are two types of measurement method for earth resistance: precision measurement method (3-pole method) and simplified measurement method (2-pole method), and the precision measurement method (3-pole method) is the basic measurement method for earth resistance.

The simplified measurement method is used when measurement cannot be performed by the precision measurement method. The precision measurement is performed by inserting two auxiliary earthing rods into the ground as shown in the figure on p. 43.

Measurement of large-scale earthing electrodes

When measuring a large-scale earthing electrode such as a mesh earthing electrode, ring earthing electrode, or earthing electrode provided by a large building structure, it cannot be accurately measured since the H(C) electrode and S(P) electrode come inside

the earth resistance area of E electrode.

If long cables are used to avoid the H(C) electrode and S(P) electrode getting inside the earth resistance area, accurate measurement cannot be carried out as it is significantly affected by noise.

Generally, measurement of large-scale earthing electrode requires a large measurement current of approx. 20 A. Use measuring instrument designed for measuring large-scale earthing electrodes for this measurement. (No measuring instrument available for this purpose from Hioki.)

Performing zero adjustment

Always perform zero adjustment prior to measurement. Make the measurement with **0Ω ADJ** on.

The range that the instrument can provide zero adjustment for is 3 Ω or less. If the measured value exceeds 3 Ω, the message **Err 0ΩADJ** appears and zero adjustment will not be executed.

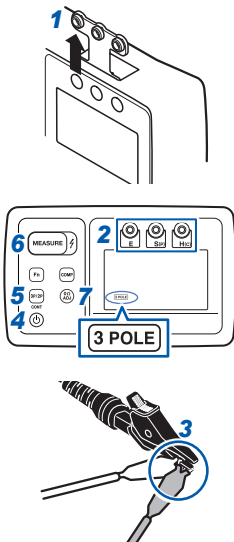

- 1** Remove the cover of the measurement terminals.
- 2** Connect black, yellow and red measurement cables respectively to E, S(P), and H(C) terminals of the instrument.
- 3** Short-circuit the tips of the three measurement cables.

- 4** Press the **Power** button to turn it on.

When zero adjustment has been enabled (**0Ω ADJ** has been on), press and hold the **0ΩADJ** button for at least 1 s to disable it.

- 5** Press the **3P/2P** button to display **3 POLE** (3-pole method).

Earth potential appears on the display.

- 6** Press the **MEASURE** button.

A measured value of approx. 0 Ω appears in approx. 8 s, and **HOLD** lights up.

When the **OPEN** indicator appears (p.23), the measurement cable may not have been connected to the measurement terminal, or the cable may have a break. Check the connection and perform cable check with a tester etc.

- 7** Press the **0ΩADJ** button.

0Ω ADJ lights up and then zero adjustment is completed.

How to disable zero adjustment

Press and hold the **0ΩADJ** button for at least 1 s while **0Ω ADJ** is on. Zero adjustment is disabled and **0Ω ADJ** is off.

Connecting measurement cables to the earthing electrodes

WARNING

Do not use the instrument to measure circuits that exceed its ratings or specifications. Damage to the instrument can cause an electric shock.



- To prevent an electric shock, be careful to avoid shorting live lines with the test leads tip.
- If the insulation on a cord melts, the metal conductor may be exposed. Do not use any cord whose metal conductor is exposed. Doing so could result in an electric shock, burn, or other hazards.

CAUTION



- To prevent cords damage, do not step on cords or pinch them between other objects. Do not bend or pull on cords at their base.



- The ends of the auxiliary earthing rod are sharp. Be careful to avoid injury.
- For safety reasons, when taking measurements, only use the measurement cables provided with the instrument.
- The cable is hardened in freezing temperatures. Do not bend or pull it to avoid tearing its shield or causing a break.

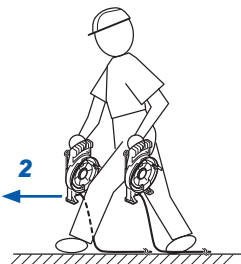
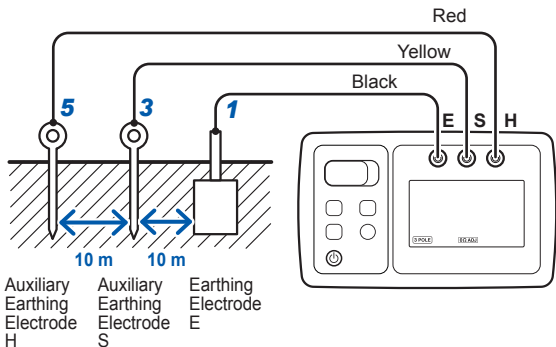

- 1** Use the measurement cable (black) to connect between earthing electrode and E terminal.
- 2** Carry two winders along to the measuring location while pulling out the measurement cables.
- 3** At the location where the measurement cable (yellow) has been fully pulled out, insert the auxiliary earthing rod into the ground and connect the measurement cable (yellow).

- 4** Carry the winder (measurement cable: red) along the straight line to a further distance between the earthing electrode E and auxiliary earthing electrode S while pulling out the measurement cable.
- 5** At the location where the measurement cable (red) has been fully pulled out, insert the auxiliary earthing rod into the ground and connect the measurement cable (red).

- Insert the auxiliary earthing rods into a moist layer in the ground. Since the instrument can accept a large resistance of auxiliary earthing electrode, the auxiliary earthing rods do not need to be inserted unnecessarily deep into the ground
- For accurate measurement, the distance between E, S, and H needs to be approx. 5 m. The measurement cables (yellow) and (red) should be positioned approx. 10 cm away from each other. Make sure the cables do not tangle or overlap together.

NOTE

Measurement on concrete

Since concrete is conductive, auxiliary earthing electrodes can be installed on concrete.

Place an auxiliary earthing rod on concrete and pour water over it, or cover the auxiliary earthing rod with a wet rag to form an auxiliary earthing electrode.

If the earth resistance of the auxiliary earthing electrode is not reduced by the above methods, place the optional 9050 Earth Nets on concrete and then position the auxiliary earthing rod on the Earth Nets and pour water over it. Before measurement, allow some time for the water to well soak into the concrete.

- As an alternative to the Earth Nets, a metal plate or aluminum foil etc. may be used.
- Since asphalt is insulator, it is generally not possible to install the auxiliary earthing electrode on asphalt. However, measurement may be possible on asphalt that has water permeability.

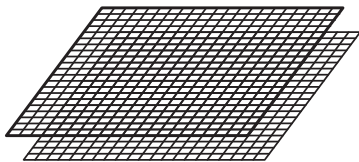

9050 Earth Nets

Measuring earth resistance

Make the measurement with **0Ω ADJ** on.

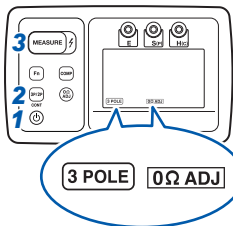

1 Press the **Power** button to turn it on.

2 Press the **3P/2P** button to display **3 POLE** (3-pole method).
Earth potential appears on the display.

3 Press the **MEASURE** button.
Automatically executes the earth potential check → auxiliary earth resistance check → earth resistance measurement in sequence.
The measurements will be completed in approx. 6 s, and then the measured value appears and **HOLD** lights up.

4 Check the measured value.

The displayed parameter can be changed after measurement.
Press the **Fn** button to switch parameters.

When NOISE appears

If the earth potential is high (25 V rms or 35.4 V peak or higher), **NOISE** and the earth potential peak value appears on the display.
When **NOISE** is on, or when ⚡ (live wire warning LED) is blinking, it is not possible to measure earth resistance.

Since leak current is flowing into the earthing electrode, first disconnect any electric equipment connected to the earthing electrode and then press the **MEASURE** button again.

- The instrument automatically detects AC/DC (\sim / \equiv) of the earth potential.

If AC/DC needs to be switched, it can be switched by pressing the **Fn** button while the current earth potential has been displayed.

- To check earth potential

After measurement of earth resistance, press the **Fn** button while **HOLD** is lit so that the earth potential will be displayed. When **HOLD** is lit, press the **3P/2P** button so that the retained value is unlocked and the current earth potential will be displayed.

When OPEN appears

The instrument automatically check whether or not each earth resistance is within the allowable range by measuring the earth resistance of the auxiliary earthing rod prior to measuring the resistance of the earthing electrode E.

If the earth resistance of the auxiliary earthing electrode exceeds the allowable range, the **OPEN** indicator appears below the measurement terminal that exceeds the allowable range and the earth resistance of the earthing electrode E will not be measured.

3

Countermeasures when OPEN appears

Take the following actions for the auxiliary earthing rod connected with the measurement terminal for which the **OPEN** indicator appears:

- Pour water
- Stick in deeper
- Insert the auxiliary earthing rod into another location
- If the clip connecting point is dirty, wipe and clean the auxiliary earthing rod with a soft cloth.

The **Fn** button allows to display the earth resistance and earth potential of each earthing electrode.

RE	Earth resistance of earthing electrode E
RS	Earth resistance of auxiliary earthing electrode S
RH	Earth resistance of auxiliary earthing electrode H
V	Earth potential

- The auxiliary earthing electrodes' earth resistance (R_S , R_H) measured values are used to automatically check whether the earthing electrode's earth resistance (R_E) can be measured. R_S and R_H do not provide the same level of resolution as the earthing electrode's earth resistance (R_E).

For the resolution of earth resistance of auxiliary earthing electrode, see "Specifications" (p.73).

- When the resistance (R_H) of auxiliary earthing electrode exceeds $5\text{ k}\Omega$, the display range becomes the range of $200\ \Omega$ without displaying the digit of $0.01\ \Omega$ even though the resistance of earthing electrode is $20\ \Omega$ or less. The following table shows examples.

If the digit of $0.01\ \Omega$ is required, pour some water over the auxiliary earthing rod (H) to reduce the earth resistance to $5\text{ k}\Omega$ or less.

Resistance R_H of auxiliary earthing electrode H	Example of indicated value (1) When $9.52\ \Omega$ is measured	Example of indicated value (2) When $13.48\ \Omega$ is measured
0 to $5\text{ k}\Omega$	$9.52\ \Omega$ (Range: $20\ \Omega$)	$13.48\ \Omega$ (Range: $20\ \Omega$)
$5\text{ k}\Omega$ to $50\text{ k}\Omega$	$9.5\ \Omega$ (Range: $200\ \Omega$)	$13.5\ \Omega$ (Range: $200\ \Omega$)

Stowing

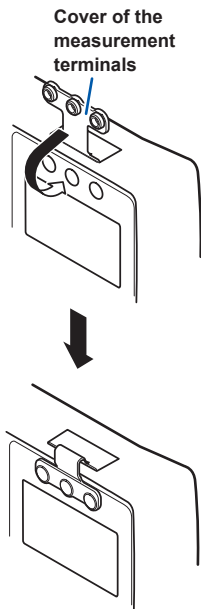

- 1** Press the **Power** button to turn it off.
- 2** Remove the measurement cables from the measurement terminals and fit the cover of the measurement terminals.
- 3** Remove the measurement cables from the auxiliary earthing rods and pull out the auxiliary earthing rods without bending them. (See p. 63 for how to pull out.)
- 4** Rewind the measurement cables (red, yellow) with the respective winders and stow the winders in the carrying case with the auxiliary earthing rods inserted into the winder's holders.
- 5** Remove the measurement cable (black) from the earthing electrode and fold it, and then stow it into the carrying case. (p.24)

3

IMPORTANT

Always fit the cover of the measurement terminals immediately after use. Any foreign object entering the measurement terminal may cause a failure.

Continuous measurement function

This function is convenient when you wish to insert an auxiliary earthing rod into the ground while checking measured values.

IMPORTANT

- Measured values provided by the continuous measurement function may differ from those provided by normal earthing resistance measurement (p.46).
- Measured values provided by the continuous measurement function are for reference purposes only. If you require precise values, be sure to measure earthing resistance using the measurement method described on p. 46.

Enabling the continuous measurement function

1 Press the **Power** button to turn it on.

2 Press and hold the **3P/2P (CONT)** button for at least 1 s until the **CONT** indicator appears on the display.

3 Press the **MEASURE** button.
The instrument will measure earthing resistance continuously. To switch the parameter displayed during measurement, press the **Fn** button.

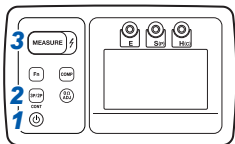

Disabling the continuous measurement function

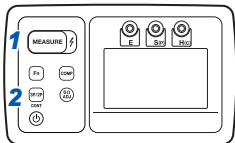

- 1 Press the **MEASURE** button during continuous measurement.**
Continuous measurement will stop.
- 2 Press and hold the **3P/2P (CONT)** button for at least 1 s until the **CONT** indicator is no longer shown on the display.**

Continuous operating time

When using four AA alkaline batteries (LR6) (reference value at 23°C)

- Approx. 3.5 hours (3-pole method, auxiliary earthing resistance of 100 Ω, measuring 10 Ω using the 20 Ω range, without Z3210 installed)
- Approx. 3 hours (3-pole method, auxiliary earthing resistance of 100 Ω, measuring 10 Ω using the 20 Ω range, with Z3210 installed, using wireless communications)

3.5 Simplified Measurement for Earth Resistance (Simplified Measurement Method, 2-pole Method)

DANGER



- Use the neutral side (ground side) of the commercial power supply for this measurement. Prior to connection, use a voltage detector etc. to make sure that it is going to be connected with the neutral side and take caution for electric shock.
- The instrument can be connected to the neutral side of an outlet with a voltage-to-ground of 300 V or less, or to the wire on the neutral side of the breaker's secondary side with a voltage-to-ground of 150 V or less. Do not connect with anything other than those specified above. It can be hazardous.

WARNING



- Use the optional L9787 Test Lead for simplified measurement for safety. Connecting the Measurement Cables L9841, L9842-11, L9842-22, L9843-51 and L9843-52 to a commercial power supply may cause electric shock.
- The instrument can output a voltage of approx. 30 V. Although the instrument has a dustproof, jet-proof and waterproof structure, the instrument should always be dried before using it for measurement so as to avoid electric shock.

WARNING



- **Removable sleeves are attached to the metal pins at the ends of the test leads. To prevent a short circuit accident, be sure to use the test leads with the sleeves attached when performing measurements in the CAT III measurement category. See “Measurement categories” (p.8).**
- **If the sleeves are inadvertently removed during measurement, stop the measurement.**

CAUTION



- When the instrument is set to 2-pole method, even if it is connected to the earth side of a commercial power supply, it will not trigger the earth leakage breaker since the measurement current is suppressed to 4 mA or less. However, do not use this method for measurement at a location where an earth leakage breaker or leakage relay with the current sensitivity of less than 10 mA has been installed, since such an earth leakage breaker or leakage relay may be triggered.
- The simplified measurement function of the instrument is a function for measuring earth resistance with small inductance component. Therefore, a resistor connected in series with inductance component of 3 mH or more may not be accurately measured.
- When carrying out measurements with the sleeves in place, be careful to avoid damaging the sleeves.
- The L9787 is a test lead specifically designed for indoor use. Do not use it outdoor.

Removing and attaching the sleeves of L9787 Test Lead

CAUTION



The tips of the metal pins are sharp and may cause injury.
Do not touch the tips.

- **Removing the sleeves**

Hold the bottom of the sleeves and pull the sleeves off.
Safely store the removed sleeves so as not to lose them.

- **Attaching the sleeves**

Insert the metal pins of the test leads into the holes of the sleeves, and firmly push them all the way in.

What is simplified measurement method (2-pole method)?

Simplified measurement method (2-pole method) is a measurement method to check the earth resistance of the equipment earthing with an earth system called TT method.

In case of not being able to insert an auxiliary earthing rod, the earth resistance is obtained with use of an existing low earthing resistor as an auxiliary electrode.

In this method, the measured value is the sum ($R_x + R_o$) of the earth resistances of the object under measurement and existing earthing resistor, according to the measurement principle. Therefore, the earth resistance of the existing earthing resistor used needs to be lower than that of the earthing electrode of the object under measurement.

In the simplified measurement method, the resistance of the earthing element used is added to the measurement result.

It is very difficult to measure 10Ω or less in the simplified method

Performing zero adjustment

Always perform zero adjustment prior to measurement. Make the measurement with **0Ω ADJ** on.

The range that the instrument can provide zero adjustment for is 3 Ω or less. If the measured value exceeds 3 Ω, the message **Err 0ΩADJ** appears and zero adjustment will not be executed.

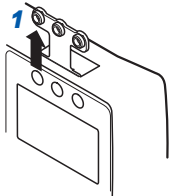

- 1** Remove the cover of the measurement terminals.
- 2** Connect the E terminal and H(C) terminal of the instrument respectively with the L9787 Test Lead (black) and L9787 Test Lead (red).
- 3** Press the **Power** button to turn it on.

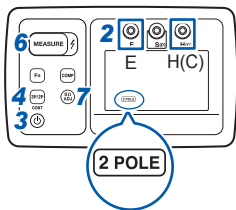

When zero adjustment has been enabled (**0Ω ADJ** has been on), press and hold the **0Ω ADJ** button for at least 1 s to disable it.

- 4** Press the **3P/2P** button to display **2 POLE** (2-pole method).

A measured value (approx. 0 V) of the earth potential appears.

- 5** Connect (short-circuit) the tips of test leads.

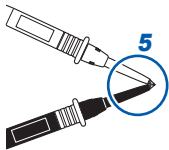

- 6** Press the **MEASURE** button.

A measured value of approx. 0 Ω appears in approx. 3 s, and **HOLD** lights up.

When the **OPEN** indicator appears below the measurement terminal, a test lead may not have been connected to the measurement terminal, or the lead may have a break. Check the connection and perform cable check with a tester etc.

- 7** Press the **0Ω ADJ** button.

0Ω ADJ lights up and then zero adjustment is completed.

How to disable zero adjustment

Press and hold the **0ΩADJ** button for at least 1 s while **0Ω ADJ** is on. Zero adjustment is disabled and **0Ω ADJ** is off.

Connecting test leads to the object under measurement

WARNING



- Do not use the instrument for measuring the voltage of commercial power supply.



- If there is a large voltage on the neutral side, ⚡ (live wire warning LED) blinks and beep sound goes off. Immediately remove the test leads from the commercial power supply.
- If the earth potential is high, attention needs to be paid for the risk of electric shock.
- To prevent an electric shock, do not exceed the every rating shown on either the instrument or each test lead, whichever is worse.

The figure below shows an example of connection in the case of using a commercial power supply that is grounded on its N (neutral) side.

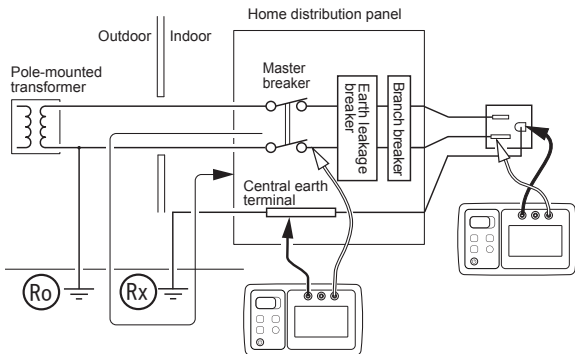

Make the measurement with **0Ω ADJ** on.

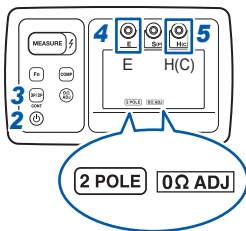

1 Use a voltage detector etc. to make sure that there is no voltage on the N (neutral) side of commercial power supply.

2 Press the **Power** button to turn it on.

3 Press the **3P/2P** button to display **2 POLE** (2-pole method).

When **3 POLE** (3-pole method) is chosen, the earth leakage breaker etc. may be triggered due to its large measurement current.

4 Connect the L9787 test lead (black) with the earthing electrode of object under measurement.

5 Connect the L9787 Test Lead (red) with the N (neutral) side of commercial power supply.

Earth potential appears on the display.

- When **NOISE** appears, a large earth potential (25V rms or 35.4V peak or higher) exists between the earth and the N (neutral) side of commercial power supply. A large leak current may be flowing through the earthing electrode of the object under measurement or through the earthing element of the commercial power supply used for measurement. Therefore, conduct an insulation resistance test or leakage current test etc. In addition, disconnect any electric equipment from the earthing electrode.
- The instrument automatically detects AC/DC of the earth potential.
- If AC/DC needs to be switched during earth potential measurement, it can be switched by pressing the **F_n** button.
- After measurement of earth resistance, press the **F_n** button while **HOLD** is lit so that the earth potential will be displayed. When **HOLD** is lit, press the **3P/2P** button so that the retained value is unlocked and the current earth potential will be displayed.
- When **NOISE** is on, or when ⚡ (live wire warning LED) is blinking, it is not possible to execute earth resistance measurement.

Measuring earth resistance

Press the **MEASURE** button so that the instrument automatically executes the following measurements in sequence. The measured value appears in approx. 3 s and **HOLD** lights up.

1 Check earth potential.

Check whether or not the peak value of the earth potential is within the allowable range.

2 Measure earth resistance.

Measure the sum ($R_x + R_o$) of the earth resistance of earthing electrode and the earth resistance on the neutral side of commercial power supply. To switch the parameter displayed during measurement, press the **Fn** button.

3

Stowing

1 Press the **Power** button to turn it off for safety.

2 Remove the test leads from the measurement terminals and fit the cover of the measurement terminals. (p.49)

3 Fold the test leads together and stow it into the carrying case.

3.6 Cautions and Tips for Measurement

Distance between earthing electrodes

When the distance between E-H(C) is l m as shown in Figure (a), if the resistance of the earthing element E is measured while changing the distance x m between the electrodes E-S(P), measurement results such as shown in Figure (b) are obtained.

Therefore, its error becomes greater as the location of the auxiliary earthing rod S(P) moves closer to the earthing element E or auxiliary earthing rod H(C).

In addition, if the distance between the electrodes E-H(C) is short, the measurement error is greater as the earth resistance under test (R_x) and the earth resistance of auxiliary earthing rod (R_c) cannot be separated from each other.

If earthing is provided by a building structure etc. in a large area, the resistance area of earth resistance (R_x) indicated in Figure (a) becomes very wide.

In order to carry out accurate measurement, the auxiliary earthing rods (S[P] and H[C]) need to be installed at a location well away from the earthing element (R_x).

As to confirm the above, carry out measurements at several locations while moving the location of the auxiliary earthing rod S(P) from the earthing element (R_x) to the auxiliary earthing rod H(C) and check whether or not there is an almost flat section shown in Figure (b) in the measured resistance even though the auxiliary earthing rod S(P) has been moved.

If no flat section is seen, the measurement distance is insufficient. Move the installation locations of the auxiliary earthing rods (S[P] and H[C]) to further locations.

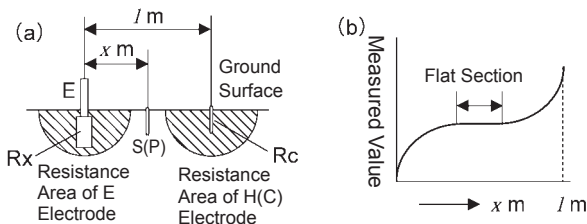

The distance between E-H(C) of the instrument can be up to 50 m by using the optional L9843-51 and L9843-52. In principle, it is possible to carry out measurement even if the distance is more than 50 m. However, the measurement result cannot be guaranteed.

Location to install auxiliary earthing rod

It is ideal to install the auxiliary earthing rod S(P) at the middle point of the straight line between the earthing element E and auxiliary earthing rod H(C).

However, if installation is not possible due to an obstacle etc., the measurement error can be reduced by installing the auxiliary earthing rod S(P) within 29° from the straight line between the earthing element E and auxiliary earthing rod H(C), wherein the location should be outside the radius of 5 m from the earthing element E and auxiliary earthing rod H(C) as shown in the figure.

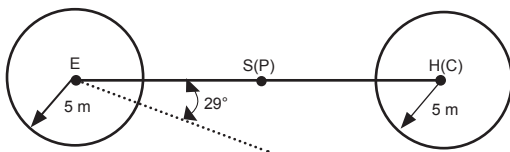

How to insert/pull out auxiliary earthing rod

How to Insert

The accessory auxiliary earthing rods are suitable for providing auxiliary earthing electrodes and are designed for thickness and hardness that allow insertion into a general ground by hand. Since it is thinner than previous models, it can be inserted into a small gap.

Wear gloves and insert it perpendicular to the ground surface. If the ground is too hard for inserting by hand, use a hammer to perpendicularly drive into the ground. Hammering the auxiliary earthing rod too hard may result in bending it. In case of not going into the ground with gentle taps, use the optional 9050 Earth Nets for measurement.

How to pull out

- Hold the loop part of the auxiliary earthing rod and pull it out while turning it.
- If it does not come out by hand, put a hard metal bar etc. (other than auxiliary earthing rod) through the loop part of the auxiliary earthing rod and pull the auxiliary earthing rod while turning it.
If pulling the auxiliary earthing rod with another auxiliary earthing rod put through the loop, it will result in bending it.
- Do not apply force to the auxiliary earthing rod from the side as it may result in bending the auxiliary earthing rod.

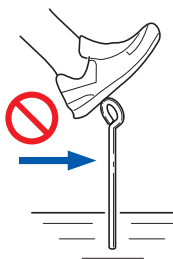
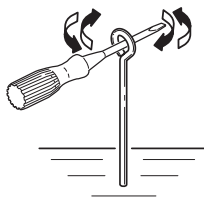
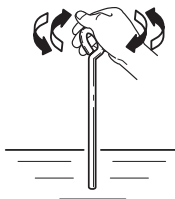

3.7 Auto Power Save (Power-saving Function)

Approx. 10 min after the last operation or the last time ⚡ (live wire warning LED) turns on or blinks, the auto power save becomes active and the screen turns off.

How to recover from auto power save

Press the **Power** button to turn the screen on.

How to disable auto power save

Turn the power on while pressing the **0ΩADJ** button.

IMPORTANT

- The settings of an disabled auto power save will not be saved when the power is turned off.
- After use, always turn off the instrument. Even when the auto power save is enabled, the instrument consumes a small amount of the battery power.

3.8 Wireless Communications Function (GENNECT Cross)

When the wireless communications function is enabled, you can review measurement data and create measurement reports on mobile devices.

For more information about this functionality, see “GENNECT Cross Official Website” (application software, free of charge).

GENNECT Cross Official Website
<https://gennect.net/en/cross/index>



3

Flashes:

Communicating

Lights up:

Wireless function on

Lights off:

Wireless function off

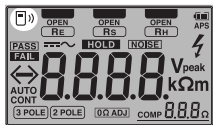

To toggle the wireless communications function on and off, press and hold the **Fn** button and the **COMP** button for at least 1 s.

- 1 Connect the **Z3210 Wireless Adapter (option)** to the instrument. (p.29)
- 2 Install the **GENNECT Cross** on your mobile device.
- 3 Turn on the instrument.
- 4 Press and hold the **Fn** button and the **COMP** button simultaneously for at least 1 s to enable the wireless communications function.
 When the wireless communications function is on,  will flash on the display.
- 5 Launch the **GENNECT Cross** and pair it with the instrument.
- 6 Select the measurement function and start measurement.

- The communication distance is approx. 10 m (line of sight). The distance over which data can be sent and received varies greatly depending on whether there are any obstructions between the paired instruments (for example, walls, metal barriers, etc.) and on the distance between the instrument and the floor (or ground). To ensure stable communication, verify adequate signal strength.
- Although the GENNECT Cross is provided free of charge, downloading or using the application software may incur Internet connection charges. Such charges are the sole responsibility of the user.
- The GENNECT Cross is not guaranteed to operate on all mobile devices.
- The Z3210 uses 2.4 GHz band wireless technology. It may not be possible for the device to establish a wireless connection when used in the vicinity of other devices that use the same frequency band, for example Wi-Fi devices (IEEE 802.11.b/g/n).
- When the app is launched for the first time (before being paired with any instrument), the instrument settings screen will be displayed.
- While the mobile device is displaying the GENNECT Cross's instrument settings screen, simply move it close to the instrument to automatically pair it with the instrument (the app can be paired with up to 8 instruments).
- Allow about 5 s to 30 s for the instrument to pair with the app after being turned on. If the instrument fails to pair within 1 min., relaunch GENNECT Cross and cycle the instrument's power.

3.9 Excel[®] Direct Entry Function (HID Function)

The human interface device (HID) profile, with which the Z3210 Wireless Adapter is equipped, is a profile same as that wireless keyboards use.

Preparatory to data entry, open an Excel[®] file on your mobile device or computer and choose a cell. Freezing the instrument's display can enter the measured values on the cells.

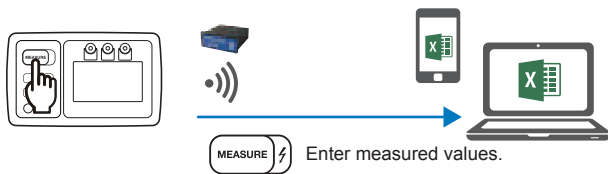

HID ON	Choose this option to enter measured values in a Excel [®] file or a text file. The instrument cannot communicate with GENNECT Cross.
HID OFF	Choose this option to use GENNECT Cross.

The setting whether the HID function has been enabled or disabled will not be saved in the instrument but in the Z3210.

- 1 Press the **Power** button to turn off the instrument.
- 2 Connect the **Z3210 Wireless Adapter (option)** into the instrument. (p.29)
- 3 Turn the power on while pressing the **COMP** button and the **0ΩADJ** button, and choose between “on” or “oFF”.



The power turns off automatically.

If “oLd” is displayed

Update the Z3210 to the latest version using GENNECT Cross (version 1.8 or later).

IMPORTANT

To switch over from the HID function to GENNECT Cross
If you start GENNECT Cross without canceling the pairing between the mobile device and the instrument, GENNECT Cross may not be able to recognize the instrument as a connectible device.

Follow the procedure below to reconnect the instrument to GENNECT Cross.

1. Use the **Bluetooth®** setting of your mobile device to delete the instrument.
2. Disable the Z3210's HID function.
3. Use the Instrument Setting of 3.GENNECT Cross to reconnect the instrument.

Confirming the HID setting

- 1 Turn the power on while pressing the **3P/2P** button.

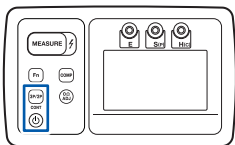

The first four digits of the serial number (nine digits in total), the last five digits, and the HID setting (only when the Z3210 is connected) are displayed in order.



(with Z3210 connected)

- 2 Press the **Power** button to turn off the instrument.

Please visit the Z3210 website at <https://z3210.gennect.net>.



Learn more here!

3.10 Activating the LCD All-on Display

This section describes how to check for screen issues by enabling all indicators on the LCD display at once.

- 1 Turn the power on while pressing the **Fn** button.

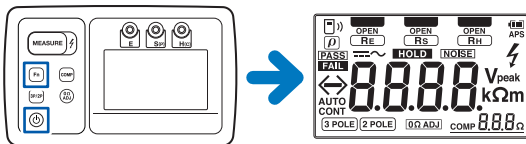

- 2 Press any button.

Its normal measurement screen will appear.

3.11 Displaying the Serial Number

- 1 Turn the power on while pressing the **3P/2P** button.

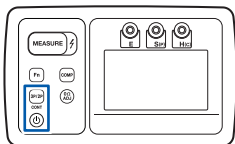

The first four digits of the serial number (nine digits in total), the last five digits, and the present HID setting (only when the Z3210 is connected) are displayed in order.

3

- 2 Press any button.

Its normal measurement screen will appear.

The serial number consists of nine digits. The first four digits indicate the year (the first two digits omitted) and the month of manufacture. Example in the figure below: manufactured in July 2020



First four digits

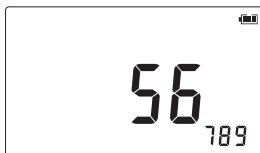

Last five digits

(Example of a serial number: 200756789)

3.12 Displaying the Version number

- 1 Turn the power on while pressing the **Fn** button and the **COMP** button.

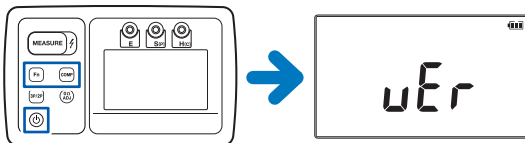

- 2 Press the **ΩADJ** button while “vEr” has been displayed. The version number “vx.xx” and the model name “6031” are displayed alternately.

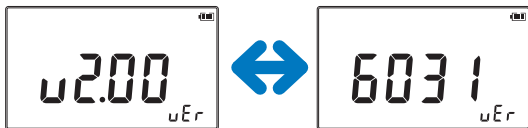

- 3 Press the **Power** button to turn off the instrument.

Update function

The firmware of the instrument can be updated using GENNECT Cross (free-of-charge application).

Conditions

GENNECT Cross	Version 1.8 or later
Firmware	Version 2.00 or later

4.1 General Specifications

Operating environment (scope of application)	Indoor, outdoor (excluding farmland*), pollution degree 3, altitude up to 2000 m (6562 ft.) *: According to the requirements regarding the regulations for open-circuit voltage in EN 61557-5
Operating temperature and humidity range	-25°C to 40°C (-13°F to 104°F): 80% RH or less (non-condensing) 40°C to 45°C (104°F to 113°F): 60% RH or less (non-condensing) 45°C to 50°C (113°F to 122°F): 50% RH or less (non-condensing) 50°C to 55°C (122°F to 131°F): 40% RH or less (non-condensing) 55°C to 60°C (131°F to 140°F): 30% RH or less (non-condensing) 60°C to 65°C (140°F to 149°F): 25% RH or less (non-condensing)
Storage temperature and humidity range	-25°C to 65°C (-13°F to 149°F): 80% RH or less (non-condensing)
Dustproof and waterproof	IP65/IP67 (EN 60529)
Drop-proofness	Drop height: 1 m, impact surface: concrete (with protector attached)
Standards	Safety Instrument: EN 61010 Measuring circuit: EN 61010 EMC: EN 61326 Earth tester: EN 61557
Power supply	AA alkaline battery (LR6) ×4 Rated supply voltage: 1.5 V DC × 4 Maximum rated power: 3 VA Available effective battery voltage: 4.5 V ±0.19 V to 6.8 V

<p>Number of measurements before replacing batteries</p>	<p>When using four AA alkaline batteries (LR6) (reference value at 23°C)</p> <ul style="list-style-type: none"> • 500 measurements (3-pole method, auxiliary earthing resistance of 100 Ω, measuring 10 Ω using the 20 Ω range, measure on at 10-sec. intervals, without Z3210 installed) • 400 measurements (3-pole method, auxiliary earthing resistance of 100 Ω, measuring 10 Ω using the 20 Ω range, measure on at 10-sec. intervals, with Z3210 installed, using wireless communications)
<p>Dimensions</p>	<p>Approx. 185W × 111H × 44D mm (7.28"W × 4.37"H × 1.73"D) (including protector, excluding cover of the measurement terminals)</p>
<p>Mass</p>	<p>Approx. 570 g (20.1 oz.) (including batteries and protector, excluding other accessories)</p>
<p>Product warranty period</p>	<p>3 years</p>
<p>Accessories</p>	<p>See "Verifying Package Contents" (p.5)</p>
<p>Options</p>	<p>See "Options (sold separately)" (p.6)</p>

4.2 Input, Output, and Measurement Specifications

Basic specifications / accuracy specifications

Measured parameters	<ul style="list-style-type: none"> • Earth resistance measurement • Earth potential measurement
A/D conversion method	$\Delta\Sigma$ method (peak voltage measurement: sequential comparison method)
Input/output terminals	<p>H terminal: Terminal that outputs the measurement voltage or that detects the voltage being measured (when using the 2-pole method)</p> <p>S terminal: Terminal that detects the voltage being measured (when not using the 2-pole method)</p> <p>E terminal: Terminal connected to the earthing electrode being measured to receive the measurement current output from the H terminal</p>
Maximum rated terminal-to-ground voltage	<p>100 V AC, DC (measurement category IV)</p> <p>150 V AC, DC (measurement category III)</p> <p>300 V AC, DC (measurement category II)</p> <p>Anticipated transient overvoltage: 2500 V</p>
Nominal operating ranges	<ul style="list-style-type: none"> • Operating temperature and humidity range: See “Operating temperature and humidity range” in “General Specifications” (p. 73). • Position: Level $\pm 90^\circ$ • Power supply voltage: Available effective battery voltage • Earth potential: See “Allowable earth potential” in “Basic specifications / accuracy specifications”. • Resistance of auxiliary earthing electrode: See “Allowable resistance of auxiliary earthing electrode” in “Basic specifications / accuracy specifications” • External magnetic field: 400 A/m or less, DC and frequency 50 Hz/60 Hz

Accuracy guarantee conditions	Accuracy guarantee period: 1 year Accuracy guarantee period after adjustment made by Hioki: 1 year Accuracy guarantee temperature and humidity range: 23°C ±5°C (73°F ±9°F), 80% RH or less
--------------------------------------	---

Measurement of earth resistance
 (R_E : Earth resistance of object under measurement,
 R_H : Earth resistance of H electrode,
 R_S : Earth resistance of S electrode)

**Conditions: auxiliary earthing electrode resistance $100 \Omega \pm 5\%$,
 earth potential 0 V**

Operation system	Voltage application, measurement of voltage and current (Effective resistance is measured by synchronous detection.)
Measurement system	2-pole method / 3-pole method, switchable
Output voltage	30 V rms or less and 42.4 V peak or less
Measurement current	3-pole method: 25 mA rms or less
	2-pole method: 4 mA rms or less
Measurement current waveform	Sine wave (Distortion factor of 5% or less)
Measuring frequency	128 Hz ± 2 Hz
Measurement time	3-pole method: Within 6 s
	2-pole method: Within 3 s

Input, Output, and Measurement Specifications

Range configuration (auto-range)	Display range ^{*1}		20 Ω ^{*2}	200 Ω	2000 Ω
	Applied conditions (R _E and R _H)	R _E	20 Ω or less	200 Ω or less	200 Ω to 2 kΩ or less
		R _H	5 kΩ or less	50 kΩ or less	50 kΩ or less
	Display range ^{*3}		0.00 Ω to 20.00 Ω	0.0 Ω to 200.0 Ω	0 Ω to 2000 Ω
	Resolution	3-pole	0.01 Ω	0.1 Ω	1 Ω
		2-pole	—	1 Ω	1 Ω
	Accuracy ^{*4} (specific uncertainty A)		±1.5% rdg ±8 dgt	±1.5% rdg ±4 dgt	
	Allowable resistance of auxiliary earthing electrode ^{*5}	R _H	5 kΩ	50 kΩ	
		R _S	5 kΩ	50 kΩ	
	Operation uncertainty	±30% rdg (applied to 3-pole method)			
Guaranteed range of operation uncertainty ^{*6}	5.00 Ω to 2000 Ω				
Phase difference tolerance	±3.5°				
Effect of positioning (E₁)	Not applicable due to digital type				
Effect of supply voltage (E₂)	Accuracy × 0.5 and within accuracy specifications				
Effect of temperature (E₃)^{*7}	Accuracy × 1.0 (−10°C to 50°C) Accuracy × 2.0 (−25°C to −10°C, 50°C to 65°C)				

Effect of earth potential (E_4)	16 2/3 Hz, 50 Hz, 60 Hz	0V to 3V		Accuracy \times 1.0	
		3V to 25V		Accuracy \times 2.0	
	DC	0V to 3V		Accuracy \times 1.0	
		3V to 10V		Accuracy \times 2.0	
	400Hz	0V to 3V		Accuracy \times 1.0	
		3V to 5V		Accuracy \times 2.0	
Allowable earth potential	25 V rms or 35.4 V peak				
Effect of the resistance of auxiliary earthing electrode (E_5) ⁵	Either R_H or R_S electrode		Variable value		
	10 k Ω or less		Accuracy \times 1.0		
	Above 10 k Ω to 50 k Ω		Accuracy \times 2.0		
Effect of system frequency (E_7)	Not applicable				
Effect of system voltage (E_8)	Not applicable				
Effect of external magnetic field	Accuracy \times 0.5				
Earth resistance of auxiliary earthing electrode auto-check (auto-check after start of measurement)	Display range	1000 Ω	10 k Ω	100 k Ω	200 k Ω
	Maximum display value	1000 Ω	10.0 k Ω	100 k Ω	200 k Ω
	Resolution	10 Ω	0.1 k Ω	1 k Ω	10 k Ω
	Accuracy	Not specified			
Auto-check for earth potential ⁸ (auto-check after start of measurement)	Display range	42 V peak			
	Maximum display value	42.0 V peak			
	Accuracy	\pm 2.3% rdg \pm 8 dgt			
Overload protection	360 V AC (for 1 min., between each terminal)				
	360 V DC (for 1 min., between each terminal)				

Automatic measurement termination	Automatic stop after measured values are finalized	
Effect of earth capacity (2-pole method)	Up to 10 nF	Within accuracy specifications
	Above 10 nF to 500 nF	Accuracy × 2.0
	Above 500 nF	Not specified
	Parallel capacitance is canceled from impedance and phase. Calculated as: $R = \left \frac{Z}{\cos\theta} \right $ (correction applied only when θ is negative) (θ : Difference between the measurement current phase and voltage signal phase; display reads "OVERFLOW" when θ is 90°.)	
Zero adjustment allowable range	3 Ω or less	
Negative resistance value processing	Displayed as absolute value	

- *1: Automatically select the minimum display range that can meet both R_E and R_H values.
- *2: 3-pole method only.
- *3: When using the 3-pole method, the minimum display value is 0.01 Ω (20 Ω range) or 0.1 Ω (200 Ω range), with the following exceptions:
 - When $R_H = 0 \Omega \pm 20 \Omega$ and $R_S = 0 \Omega \pm 20 \Omega$
 - When $R_H = 100 \Omega \pm 20 \Omega$ and $R_S = 100 \Omega \pm 20 \Omega$
 - When $R_H = 500 \Omega \pm 20 \Omega$ and $R_S = 500 \Omega \pm 20 \Omega$
- *4: Applied after zero adjustment, $\pm 0.3 \Omega$ is added before zero adjustment (when using the L9841).
- *5: Does not apply when using the 2-pole method, in which case the auxiliary earthing electrode's allowable resistance is used as the upper limit value.
- *6: It shall be the range in which the operation uncertainty within $\pm 30\%$ is guaranteed; applied to 3-pole method.

- *7: Applied in the range excluding 18°C to 28°C.
- *8: Function to check whether or not the peak of earth potential is within the allowable range; no AC coupling; display the peak value (peak on + side).

Earth potential measurement		
DC/AC auto-detection range	0.3 V DC ± 0.2 V or higher is detected as DC Manual switching function provided Pulsating flow with superimposed AC component that periodically zero-crosses is detected as AC.	
Measurement method	Average value rectification, RMS value indication	
Terminal for voltage measurement	3-pole method: Between S terminal (+) and E terminal (-)	
	2-pole method: Between H terminal (+) and E terminal (-)	
Overload protection	360 V AC (for 1 min., between each terminal)	
	360 V DC (for 1 min., between each terminal)	
Display refresh interval	Within 1 s	
Input resistance	4 M Ω or higher (DC / 50 Hz / 60 Hz)	
Response time	Within 2 s (when input voltage is changed from 0 V to 30 V)	
Effect of temperature	Accuracy $\times 1.0$ (-10°C to 50°C , applied in the range excluding 18°C to 28°C)	
	Accuracy $\times 2.0$ (-25°C to -10°C , 50°C to 65°C)	
Range configuration	Display range	30 V rms
	Maximum display value	30.0 V rms
	Resolution	0.1 V
	Accuracy	DC
50 Hz/60 Hz		$\pm 2.3\%$ rdg ± 8 dgt

5.1 Repair, Inspection, and Cleaning

WARNING



Do not attempt to modify, disassemble, or try to repair the instrument. Doing so may cause a fire, electric shock, or injury.

Calibrations

The calibration frequency varies depending on the status of the instrument or installation environment. We recommend that the calibration frequency is determined in accordance with the status of the instrument or installation environment and that you request that calibration be performed periodically.

Cleaning

IMPORTANT

Never use solvents such as benzene, alcohol, acetone, ether, ketones, thinners or gasoline, as they can deform and discolor the case.

- If the instrument becomes dirty, slightly moisten a soft cloth moistened with water or a neutral detergent and wipe the instrument clean.
- When rinsing with water, make sure that the battery cover has been attached. Make sure that the protector has been removed and rinse with room-temperature water. Washing with hot water may compromise the instrument's waterproofness.
- After cleaning, thoroughly wipe off water of the instrument and protector. Completely dry them before putting the protector on.

- Do not put water while the battery cover has been taken off. It may cause failure due to water intrusion.
- When replacing the batteries after cleaning, the replacement should be carried out after the instrument has been completely dried.
- The instrument is waterproof to a water depth of 1 m for 30 min. Do not soak and wash the instrument. Do not soak the instrument into hot water.
- Do not wash the instrument with a washing machine
- Do not use any electronic appliance such as a dryer or microwave for drying the instrument.
- Wipe the LCD gently with a soft, dry cloth.

If the instrument is not to be used for an extended period of time

IMPORTANT

To avoid corrosion and damage to the instrument from battery leakage, remove the batteries from the instrument if it is to be stored for a long time.

Disposal

Dispose of the instrument in accordance with local regulations.

Protector

A protector is available as a service part. Contact your authorized Hioki distributor or reseller.

5.2 Troubleshooting

If damage is suspected, read the “Before sending the instrument for repair” (p. 86) section before contacting your authorized Hioki distributor or reseller.

Be sure to follow these precautions when transporting the instrument:

- Remove batteries, accessories, and optional equipment from the instrument in order to avoid damage. Additionally, use the original packing materials, and be sure to double box the instrument. Accidental damage suffered in transit is not covered by the warranty.
- Attach a description of the issue when sending out your instrument for repair.

Before sending the instrument for repair

If it is not operating correctly, check the following items.

Symptom	Cause, check, countermeasure
<p>The power does not turn on.</p>	<p>There are no batteries inside. The batteries have been incorrectly installed. → Refer to how to install the batteries. Have the batteries been depleted? → Replace the batteries with new ones If the power still will not turn on, the instrument has a failure and needs to be repaired. (“Inserting/Replacing Batteries” [p. 26])</p>
<p>The instrument is unintentionally turned off during a measurement.</p>	<p>The batteries to be used may have been left for a long time. → Battery voltages may recover as time proceeds, which seem to be high enough to work. However, such batteries, which provide only a little energy, cannot work. Replace the batteries with new ones. The batteries have high internal resistance. → Such high-internal-resistance batteries, which provide only a little energy even if they are new, cannot work. Use batteries produced by other manufactures. The instrument is used in a low temperature (below freezing point). → At low temperatures, the batteries’ internal resistance increases, so the power may turn off during measurement. Use lithium batteries or warm the batteries before measurement.</p>

Symptom	Cause, check, countermeasure
<p>The resistance of auxiliary earthing electrode does not come down (precision measurement).</p>	<p>Bad connection of measurement cable, the ground is dry.</p> <p>→ Make sure that the measurement cables are connected to the earthing electrode/ auxiliary earthing rod.</p> <p>→ Short-circuit the tips of the measurement cables and then carry out the measurement.</p> <p>If the measured value is approx. 0Ω, it is caused by a high earth resistance of the earthing electrode. Insert the auxiliary earthing rod deeper.</p> <p>Alternatively, pour water over the auxiliary earthing rod. If the resistance still will not come down, move the auxiliary earthing electrode to another location.</p> <p>The measurement cables (yellow) and (red) should be positioned approx. 10 cm away from each other.</p>
<p><u>NOISE</u> appears and measurement is not allowed (cannot measure the earth resistance due to high earth potential).</p>	<p>The earth potential exceeds the value that can be accepted by the instrument. A large leakage current may be flowing into the earthing electrode from equipment that has been connected to the earthing electrode. Or, the earth resistance of earthing electrode may be high and a large earth potential may have occurred by a small leakage current.</p> <p>→ Remove the equipment that has been connected to the earthing electrode and then carry out the measurement. ("When NOISE appears" [p.46])</p>

Symptom	Cause, check, countermeasure
<p>Trying to carry out measurement on a newly built residential building, but the simplified measurement (2-pole method) is not allowed.</p>	<p>Measurement is not allowed if the electricity has not been distributed from the power company.</p>
<p>The measured value becomes approx. 0 Ω when measuring with use of an existing auxiliary earthing electrode for measurement.</p>	<p>The earthing electrode and the auxiliary electrode for measurement may have been connected through concrete. → Drive an auxiliary earthing rod into the ground and then carry out measurement instead of using an auxiliary electrode for measurement.</p>
<p>Small noise occurs inside the instrument during measurement.</p>	<p>It is the noise from the oscillator circuit inside the instrument. It is not a failure.</p>
<p>The measured value is high.</p>	<p>It has been set to 2-pole method. → Press the 3P/2P button to select 3-pole method.</p>
<p>Measurement is not allowed when trying to measure with an earth net laid on asphalt.</p>	<p>Since asphalt is insulator, measurement is not possible with an earth net.</p>
<p>Auxiliary earthing rod has been bent.</p>	<p>It is recommended to purchase the L9840 Auxiliary Earthing Rod. (Commercially available pegs have sharp tips, which may damage the carrying case.)</p>

5.3 Error and Status Codes

Code	Description	Solution
Err 0QADJ	Zero adjustment is outside the allowable range, zero adjustment has been executed while it is not on HOLD.	Execute zero adjustment again in accordance with the zero adjustment procedure. (p.40, p.55)
Err1	Abnormality in firmware	Instrument failure. Contact your authorized Hioki distributor or reseller to organize repair.
Err2	Adjustment data damaged	
Err4	Setting data damaged	
Err5	Abnormality in measurement circuit	
Err8	Z3210 communications error (connection failure; Z3210 or hardware failure)	Take the following actions: <ul style="list-style-type: none"> • Reinstall the Z3210. • Install a different Z3210. (p.29) If the error persists, you are experiencing a instrument failure. Contact your authorized Hioki distributor or reseller to organize repair.
Err9	Version update error	Update the instrument again using GENNECT Cross.
APS →P.oFF	Instrument powered off by APS	Cycle the power.
bAtt →P.oFF	Instrument powered off due to supply voltage drop	

6.1 Earth Resistance

The resistance between earthing electrode and ground is usually called earth resistance. To be exact, it is the sum of the resistance of earthing conductor, the contact resistance between earthing conductor and ground, and the resistance of ground.

Earth resistance is different from commonly known resistors and has the following special characteristics.

- **Polarizing action**

Since the ground has characteristics just like electrolyte, it has the polarizing action, and if DC current flows through, an electromotive force occurs in the opposite direction to the current, interfering with correct measurement. Therefore, rectangular wave or sine wave of several tens Hz to 1 kHz is usually used to measure the earth resistance.

- **Special configuration**

Earth resistance is a resistance between earthing electrode and ground. It is not possible to take it out from the ground and measure it.

Since the resistivity of ground is relatively high, a voltage drop occurs near the electrode through which the current to be measured flows. Therefore, each electrode (E electrode, S[P] electrode, H[C] electrode) needs to be away from each other to approx. 10 m to accurately measure the resistance of earthing electrode.

- **Presence of disturbance factors**

There are disturbance factors such as effects from earth potential and auxiliary earthing electrode in the measurement of earth resistance.

The earth potential caused by a leakage current from a device

that has been connected to the earthing electrode affects the measured value as it is superimposed over the signal to be detected by the earth tester. In addition, if the earth resistance of auxiliary earthing electrode is high, the measurement current is reduced, making it susceptible to noise such as earth potential. The instrument employs a system that is less susceptible to these disturbances and allows accurate measurement under adverse conditions.

6.2 Measurement Principle

While applying a voltage of AC power supply between H(C) electrode and E electrode, the flowing AC current I is measured with an ammeter. In addition, the voltage V between S(P) electrode and E electrode that is caused by the flow of the current I is measured by an AC voltmeter.

The earth resistance R_x of E electrode is derived from the measured current I and voltage V . It is not possible to accurately measure the voltages between H(C) and E electrodes and between H(C) and S(P) electrodes.

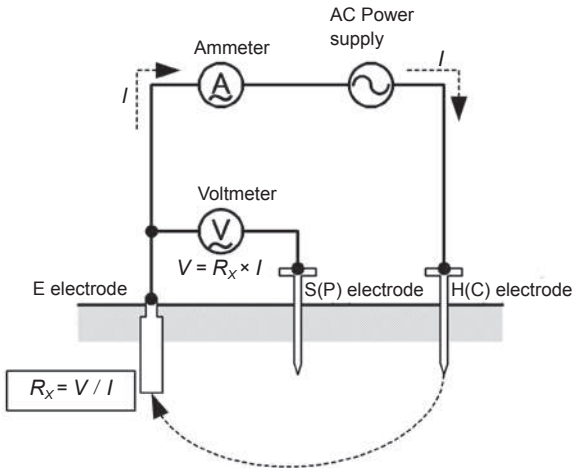

Warranty Certificate

HIOKI

Model	Serial number	Warranty period Three (3) years from date of purchase (___ / ___)
-------	---------------	--

Customer name: _____

Customer address: _____

Important

- Please retain this warranty certificate. Duplicates cannot be reissued.
- Complete the certificate with the model number, serial number, and date of purchase, along with your name and address. The personal information you provide on this form will only be used to provide repair service and information about Hioki products and services.

This document certifies that the product has been inspected and verified to conform to Hioki's standards.

Please contact the place of purchase in the event of a malfunction and provide this document, in which case Hioki will repair or replace the product subject to the warranty terms described below.

Warranty terms

1. The product is guaranteed to operate properly during the warranty period (three [3] years from the date of purchase).
If the date of purchase is unknown, the warranty period is defined as three (3) years from the date (month and year) of manufacture (as indicated by the first four digits of the serial number in YYYY format).
2. If the product came with an AC adapter, the adapter is warranted for one (1) year from the date of purchase.
3. The accuracy of measured values and other data generated by the product is guaranteed as described in the product specifications.
4. In the event that the product or AC adapter malfunctions during its respective warranty period due to a defect of workmanship or materials, Hioki will repair or replace the product or AC adapter free of charge.
5. The following malfunctions and issues are not covered by the warranty and as such are not subject to free repair or replacement:
 - 1. Malfunctions or damage of consumables, parts with a defined service life, etc.
 - 2. Malfunctions or damage of connectors, cables, etc.
 - 3. Malfunctions or damage caused by shipment, dropping, relocation, etc., after purchase of the product
 - 4. Malfunctions or damage caused by inappropriate handling that violates information found in the instruction manual or on precautionary labeling on the product itself
 - 5. Malfunctions or damage caused by a failure to perform maintenance or inspections as required by law or recommended in the instruction manual
 - 6. Malfunctions or damage caused by fire, storms or flooding, earthquakes, lightning, power anomalies (involving voltage, frequency, etc.), war or unrest, contamination with radiation, or other acts of God
 - 7. Damage that is limited to the product's appearance (cosmetic blemishes, deformation of enclosure shape, fading of color, etc.)
 - 8. Other malfunctions or damage for which Hioki is not responsible
6. The warranty will be considered invalidated in the following circumstances, in which case Hioki will be unable to perform service such as repair or calibration:
 - 1. If the product has been repaired or modified by a company, entity, or individual other than Hioki
 - 2. If the product has been embedded in another piece of equipment for use in a special application (aerospace, nuclear power, medical use, vehicle control, etc.) without Hioki's having received prior notice
7. If you experience a loss caused by use of the product and Hioki determines that it is responsible for the underlying issue, Hioki will provide compensation in an amount not to exceed the purchase price, with the following exceptions:
 - 1. Secondary damage arising from damage to a measured device or component that was caused by use of the product
 - 2. Damage arising from measurement results provided by the product
 - 3. Damage to a device other than the product that was sustained when connecting the device to the product (including via network connections)
8. Hioki reserves the right to decline to perform repair, calibration, or other service for products for which a certain amount of time has passed since their manufacture, products whose parts have been discontinued, and products that cannot be repaired due to unforeseen circumstances.

HIOKI E.E. CORPORATION

<http://www.hioki.com>

18-07 EN-3

HIOKI

<http://www.hioki.com>



**All regional
contact
information**

HEADQUARTERS

81 Koizumi
Ueda, Nagano 386-1192 Japan

HIOKI EUROPE GmbH

Rudolf-Diesel-Strasse 5
65760 Eschborn, Germany
hioki@hioki.eu

1906 EN

Edited and published by HIOKI E.E. CORPORATION

Printed in Japan

- CE declarations of conformity can be downloaded from our website.
- Contents subject to change without notice.
- This document contains copyrighted content.
- It is prohibited to copy, reproduce, or modify the content of this document without permission.
- Company names, product names, etc. mentioned in this document are trademarks or registered trademarks of their respective companies.